

HYDRAULIC DIAPHRAGM METERING PUMPS

SERIES

XR

SPRING RETURN



TRANSLATION OF ORIGINAL INSTRUCTIONS

ATTENTION: Industrial machinery not intended for use by non-professional operators. These instructions are intended for qualified personnel.

PUMP TYPE	XR	XRN	XR...MU	XRN...MU
MOTOR	SPECIAL	SPECIAL	UNEL-MEC	UNEL-MEC

HYDRAULIC SYSTEM WITH BUILT-IN SAFETY VALVE, MECHANICALLY ACTUATED OIL REPLENISHING VALVE AND AIR-BLEED VALVE



Doc. N°	UT 4782	Rev.	0	Lang.	ENG	1st Issue	20.09.12
Prepared	E. SERRAINO	Checked	S. COPELLI	Replace			-

Rev.	Revised sections	Checked	Date

OPERATING MANUAL



An IDEX Water & Wastewater Business. 



English

OBL JOB No.					
CUSTOMER					
CUSTOMER ORDER No.					
METERING PUMP TYPE					
ANNEXES					
ITEM/S					
SERIAL NUMBER/S					

INDEX

ENGLISH**GB**

1. INTRODUCTION	4
1.1 RECEIVING INSPECTION	4
1.2 SUPPLY CONDITIONS.....	4
1.3 NOTES ON ELECTROMAGNETIC COMPATIBILITY.....	4
1.4 USE IN POTENTIALLY EXPLOSIVE AREAS.....	4
2. GENERAL INFORMATION.....	4
2.1 PERSONNEL RESPONSIBLE FOR MACHINE OPERATION.....	5
2.1.1 "Operator" personnel.....	5
2.1.2 "Mechanical Maintenance" personnel.....	5
2.1.3 "Electrical Maintenance" personnel.....	5
2.2 TESTING AND GUARANTEE.....	5
2.2.1 Testing.....	5
2.2.2 Guarantee	5
2.3 INSTRUCTIONS FOR REQUESTING SPARE PARTS.....	6
2.3.1 Spare parts.....	6
2.3.2 Changes and manufacturing of spare parts without approval.....	6
2.4 LIABILITY EXCLUSION	6
2.5 RESTRICTIONS REGARDING THIS DOCUMENT	6
3. SAFETY WARNINGS	6
3.1 SYMBOLS AND SUGGESTIONS IN THESE INSTRUCTIONS.....	7
3.2 DANGER.....	7
3.3 INDIVIDUAL PROTECTIVE EQUIPMENT.....	7
3.4 ADDITIONAL NOTE FOR ATEX PUMPS	7
3.5 SUITABILITY VERIFICATION FOR EFFECTIVE APPLICATION/USE.....	8
4. TRANSPORT, HANDLING AND STORAGE.....	8
4.1 TRANSPORT, LIFTING AND HANDLING.....	8
4.2 STORAGE CONDITIONS.....	8
4.3 DIMENSIONS AND WEIGHTS	8
5. DESCRIPTION	8
5.1 IDENTIFICATION NAMEPLATE	9
5.2 IDENTIFICATION CODE.....	9
5.3 AMBIENT AND DESIGN TEMPERATURE.....	10
5.4 WORKING PRINCIPLE.....	10
5.5 THE FLOW RATE.....	10
5.6 INTENDED USE.....	11
5.7 REASONABLY EXPECTED IMPROPER USE.....	11
5.8 PROHIBITED USE.....	11
5.9 NOISE.....	12
5.10 VIBRATIONS	12
5.11 TYPE OF ELECTRIC MOTOR IN RELATION TO PUMP TYPE.....	12
5.11.1 Powering the electric motor with inverter	12
5.12 TECHNICAL DATA	12
5.12.1 Pumps type XR	12
5.12.2 Pumps type XRN	13
5.13 FLOW RATE ADJUSTMENT SYSTEM	13
5.13.1 Manual adjustment via graduate knob and linear vernier	13
5.13.2 Manual adjustment via handwheel with fixed reaction dial	13
5.13.3 Automatic adjustment by means of actuator	13
5.14 INTERNAL SAFETY VALVE ON HYDRAULIC OIL CIRCUIT	13
6. INSTALLATION AND COMMISSIONING	13
6.1 INSTRUCTIONS FOR PROPER INSTALLATION.....	13
6.1.1 Pump and pipeline fixing.....	14
6.1.2 Connecting to plant pipelines.....	14
6.1.3 Connecting the motor to the mains	14
6.2 SUCTION PIPELINE	15
6.2.1 Suction pipeline path	15
6.2.2 Suction pipeline for viscous liquids.....	16
6.2.3 Filter on suction pipeline	17
6.2.4 Calibration pot	18
6.3 DISCHARGE PIPELINE	18
6.3.1 External safety valve	19

6.3.2	Pulsation dampener	19
6.3.3	Pressure gauge	21
6.4	EXAMPLE OF PLANT FOR METERING PUMPS	21
6.5	ELECTRIC MOTOR INSTALLATION.....	21
6.5.1	Pump type XR, XRN.....	22
6.5.2	Pump type XR...MU, XRN...MU	22
6.5.3	Check and change the direction of rotation	22
6.6	DESIGN DATA CHECK.....	22
6.6.1	Environmental conditions	22
6.6.2	Installation conditions.....	22
6.7	START-UP	22
6.7.1	Checks before start-up.....	22
6.7.2	Checks during operation	23
6.7.3	Abnormal conditions	23
6.7.4	Prolonged stops	23
7.	ROUTINE MAINTENANCE.....	23
7.1	OPERATING PRECAUTIONS	23
7.2	CONSULTING TECHNICAL DOCUMENTATION	24
7.3	PERIODIC OPERATIONS	24
7.3.1	Checks of normal operation.....	24
7.3.2	Checks of electrical connections.....	24
7.3.3	Checks of pump connection to plant pipeline	24
7.3.4	General and surface cleaning.....	24
7.3.5	Protection against corrosion	25
7.3.6	Verification of thermal protections	25
7.3.7	Painting check (if foreseen).....	25
7.3.8	Hydraulic/Lubricant oil check.....	25
7.4	RECOMMENDED SPARE PARTS.....	25
7.4.1	Pumps with PLASTIC material pumphead	25
7.4.2	Pumps with METALLIC material pumphead	25
7.5	DISMANTLING, REPLACEMENT AND REASSEMBLY	25
7.5.1	Personnel qualifications - Customer service.....	26
7.5.2	Disconnecting electrical connections.....	26
7.6	VALVE VERIFY AND/OR REPLACEMENT.....	26
7.6.1	Pumps type XR-XRN 2.15.....	26
7.6.2	Pumps type XR-XRN 2.30.....	27
7.6.3	Pumps type XR-XRN 6.20; 6.30; 6.38; 6.48	27
7.7	HYDRAULIC/LUBRICANT OIL CHANGE	28
8.	SPECIAL MAINTENANCE	30
8.1	TECHNICAL DOCUMENTATION.....	30
8.2	HYDRAULIC SYSTEM MAINTENANCE	30
8.2.1	Diaphragm condition check	30
8.2.2	Diaphragm replacement.....	31
8.2.3	Pumphead tightening torque values	32
8.2.4	Pumps with plastic material pumphead: Recommendations	32
8.3	BEARINGS REPLACEMENT	32
8.3.1	Reassembling.....	33
8.4	CHANGE OF INTERNAL SAFETY VALVE SET PRESSURE	33
9.	OTHER INFORMATION.....	33
9.1	FAULTS AND OPERATING PROBLEMS	33
9.1.1	Flowrate lower than expected.....	33
9.1.2	Flow rate irregular or higher than expected	33
9.1.3	Overheating of pump body and/or motor.....	34
9.2	DISCONNECTION FROM THE PLANT AND SENDING TO OBL FOR MAINTENANCE.....	34
9.3	STORAGE FOR LONG PERIODS	34
9.4	DISPOSAL AND DEMOLITION.....	34
10.	MANDATORY INSTRUCTION FOR RETURNING GOOD IN OBL	34
10.1	MANDATORY DIRECTIONS FOR SENDER	35
10.2	CLEANING OF EQUIPMENT	35
10.3	GOODS REJECTED TO SENDER	35
11.	OVERALL AND SECTIONAL DRAWINGS.....	35
12.	CE CONFORMITY DECLARATION	35

1. INTRODUCTION

The machines covered by the following "instructions" are **intended for operation in industrial areas** and therefore cannot be treated as products for retail (consumer).



This document therefore contains information to be used by qualified personnel only.

They must also be integrated by laws and technical regulations in force and do not replace any plant regulation provisions or any additional requirements, either legislative or non, which have been issued for safety purposes.

GB

1.1 RECEIVING INSPECTION

All material relative to supply is delivered to the shipper in perfect condition after thorough final testing and packaging (where applicable). Inspect goods immediately upon receipt and check that:

- the goods received correspond to the order made
- packaging (where applicable) has not undergone damage due to transport or has not been tampered with

If the packaging is damaged or tampered with, immediately check (quantity, quality and form):

- actual conditions of goods
- presence of all accessories or spare parts



ATTENTION: Should anomalies or damage be found IMMEDIATELY ISSUE A COMPLAINT WITH THE COURIER and inform OBL as well. We suggest contacting OBL customer support before commissioning.

1.2 SUPPLY CONDITIONS

All the XR series pumps are supplied as follows:

- ready to be installed as specified in the job order
- pre-tested in accordance with internal specifications
- unpainted, but treated to ensure high protection against corrosion (painted only if specifically requested)
- **completed** with lubricant oil and hydraulic oil (where applicable)

1.3 NOTES ON ELECTROMAGNETIC COMPATIBILITY

The XR series pumps, if installed properly and **with direct power supply from the mains**, comply with emission limits set by regulations relating to electromagnetic compatibility (EMC - General requirements for industrial environments).



Pumps for powering by means of inverters or other electronic equipment must be especially ordered for said use. All checks and any necessary measures to comply with emission limits set by regulations shall be at charge and responsibility of the end user.

1.4 USE IN POTENTIALLY EXPLOSIVE AREAS



WARNING: XR and XRN pumps can not be ATEX ! DO NOT USE in potentially explosive areas !



XR...MU and XRN...MU pumps in STANDARD version are not suitable for use in potentially explosive areas !



WARNING: The XR...MU and XRN...MU pumps for hazardous areas must be especially ordered for said use ! In potentially explosive atmospheres must be used only ATEX execution pumps with a flameproof motor !

All **pumps in ATEX execution** differ from **NON ATEX** (or standard execution) pumps in that they are fitted with a second identification plate with specific indication of the data required by the directive.

2. GENERAL INFORMATION

The purpose of these instructions is to refer information deemed necessary for understanding as much as possible about and facilitating the installation, commissioning, use and maintenance of **hydraulic diaphragm metering pumps XR series with spring return mechanism**, more briefly called **XR series pumps**.

Although the family of **XR series pumps** include pumps **XR** and **XRN**; each type may have several variants (see "Identifying code" and "Technical data"), the technical information contained in this instructions manual **are appropriate and equally applicable** (except where specifically stated) **for any pump whose identifying code start with the letter "XR"**.

OBL reserves the right to modify the characteristics of its products at any time to apply the latest technological innovations. The information contained in this document is therefore subject to change without notice.

2.1 PERSONNEL RESPONSIBLE FOR MACHINE OPERATION

Personnel, before operating the machine, must be professionally trained (preferably an employee of the sector) and must have read and understood the instructions contained in this manual.

The employer must instruct all staff on the risks of accidents and on devices and clothing to be used for individual safety, on the risks arising from noise emission and on general provisions laid down by European Directives and legislation in the country of machine installation.

GB

2.1.1 "Operator" personnel

The term "Operator" is intended as personnel that carry out the following tasks on the machine:

- performs the functions needed for operation
- uses the adjustment and operating commands
- performs simple actions related to operation
- performs any cleaning and daily inspection operations
- reports defects or machine malfunctioning



The operator must work on the machine while protective guards are mounted and safety devices active

2.1.2 "Mechanical Maintenance" personnel

Intended as personnel that operates on the machine in all operating conditions and at all protection levels.

Performs all types of repairs or mechanical adjustments but does not work on electrical installations.

2.1.3 "Electrical Maintenance" personnel

Intended as personnel that operates on the machine in all operating conditions and at all protection levels.

Performs all types of repairs or electrical installations adjustments, even in the presence of voltage.

2.2 TESTING AND GUARANTEE

2.2.1 Testing

Each OBL metering pump is a reliable quality product, subject to careful final inspection to ensure their proper functioning and found compliance with the specified performance. The final test results, if specifically requested by contract, are registered in special forms and made available to the Customer. Pump which successfully pass the final tests is then labelled with a green sticker applied on the product by the testing supervisor.

2.2.2 Guarantee

Metering pumps, as with all other OBL products, are guaranteed for a period of twelve (12) months of operation but in any case no longer than eighteen (18) months from the date of delivery (document of transport refers).

The guarantee covers the replacement, free of charge and ex-factory in Segrate (MILANO) ITALY, of any component found to be defective in material or processing by the OBL technical office.

The guarantee IS NOT VALID in the following cases:

- components subject to normal wear (e.g. gaskets, seals, O-rings);
- if installation and/or use do not meet the technical conditions of sale and instructions;
- if the pump has been tampered with or disassembled;
- if the pump has been sold to third parties.



ATTENTION: Always avoid disassemble or attempted repair of products still under guarantee, as doing so will void the guarantee. Always contact OBL customer service for information.

In the case of a guarantee claim, the pump must be sent postage paid to the OBL factory in Segrate (MILANO) ITALY, accompanied by a description of the anomaly complained.

For safety reasons BEFORE shipping, the sender MUST ALWAYS contact OBL customer service (Tel. +39-02-26919.1, info@obl.it) and operate as indicated in point "Instructions for returning goods in OBL".

2.3 INSTRUCTIONS FOR REQUESTING SPARE PARTS

Find and study the sectional drawing of the pump in use, if necessary contact OBL to obtain a copy. Analyze the conditions and identify the damaged components. Using the nomenclature of the sectional drawing, make a list of the parts those components (mention the sectional drawing number and the component position code) and send to the OBL Sales Office, always specifying:

- type of metering pump (complete model number)
- metering pump serial number
- OBL job n° (as an alternative to the serial number)



N.B.: These informations can be found on metering pump nameplate.

2.3.1 *Spare parts*

Standard components (screws, nuts, ball bearings, etc...) are also available directly from specialised dealers. **Replace any other components with original OBL spare parts.**

2.3.2 *Changes and manufacturing of spare parts without approval*



Modifications ARE NOT allowed. Original OBL spares and accessories are to be used in order to assure the conformity with safety rules. OBL declines any responsibility in case of use of non-original parts and warranty will be no longer valid.

2.4 LIABILITY EXCLUSION

OBL is unable to monitor the observance of the instructions given in this manual, nor verify the actual working conditions and installation of the equipment, the correct operation, the using and maintenance of the machines and accessories.

An incorrect installation, or misuse of the machine, may cause serious damage and may pose a danger to persons or property. Any anomalies must be reported to the maintenance supervisor. The user is not authorized to tamper with the machine for any reason.



Attempts to disassemble, modify or tamper in general by unauthorized personnel will void the guarantee and will release OBL from any liability for damage caused to persons or property resulting from such actions.

OBL is considered released from any liability in the following cases:

- improper installation;
- improper use of the machine by non-professional or inadequately trained operators;
- use not in compliance with regulations in the Country of use;
- lack of maintenance or improperly performed;
- use of non-original spare parts or incorrect parts for the model in question;
- total or partial failure to observe the instructions;
- exceptional environmental events.

2.5 RESTRICTIONS REGARDING THIS DOCUMENT

This document is property of OBL S.r.l. together with the technical information contained in it. Modification, reproduction or copying (in part or whole) without written permission is prohibited. Violations will be prosecuted by law.

3. SAFETY WARNINGS



METERING PUMPS ARE INDUSTRIAL MACHINERY NOT INTENDED FOR USE BY NON-PROFESSIONAL OPERATORS. THESE INSTRUCTIONS ARE INTENDED FOR QUALIFIED PERSONNEL.



FULLY AND CAREFULLY study these instructions before installing and starting the pump. Failure to respect safety recommendations can damage the machine or compromise its operation.

For a correct handling and maintenance strictly follow present information. It is of key importance that these are read by the installer and the maintenance supervisor. This document should be stored near the machine in a safe, dry place, and in any case always made easily and readily available for future reference.

Keep always the instructions and warnings presents directly on the equipment in good and readable condition (replace if necessary):

- Equipment nameplate
- Arrow indicating the motor direction of rotation

- Warning and service information stickers

3.1 **SYMBOLS AND SUGGESTIONS IN THESE INSTRUCTIONS**



This symbol indicates important information for preventing faults and/or damage to equipment or personnel.



This symbol indicates danger due to the presence of electricity.



This symbol indicates a danger that may cause an explosion.



This symbol represents the metering pump schematically.

3.2 **DANGER**

Metering pumps are machines with dangerous parts. Therefore:

- **improper use or tampering**,
- **removal of guards** or disconnection of protective devices,
- **inadequate inspection or maintenance** can cause serious damage to persons or property.

In particular, personnel must be informed of danger due to:



- **live parts**



- **rotating or moving parts**



- **handled fluid under pressure and/or corrosive**



- **hot surfaces**

The safety supervisor must ensure and guarantee that:

- the machine is handled, installed, commissioned, inspected, maintained and repaired **by qualified personnel only**, that must have:
- specific technical training and experience
- knowledge of technical regulations and applicable laws
- knowledge of general, national, local and plant safety requirements
- ability to recognise and avoid all possible danger.

Failure to follow these instructions, negligence or an incorrect or improper use of the machine by unauthorised and unqualified personnel may cause risk to persons or property, resulting in cancellation of the guarantee by OBL.



The safety of these machines can be compromised if they are used improperly or tampered with.

Metering pumps must be used only if they are in perfect technical condition, also considering safety aspects and danger. The smooth operation of these machines, their durability and operating efficiency depend on the observance of these details. We declines any responsibility for bodily injury or property damage caused by improper use of our equipment.

3.3 **INDIVIDUAL PROTECTIVE EQUIPMENT**

Any operation on the machine must be undertaken in compliance with safety regulations and safety warnings.

The safety supervisor must ensure compliance with applicable laws and safety regulations enacted for safety, and monitor that all personnel are equipped and always use appropriate individual protective equipment.



Appropriate individual safety devices must always be used to ensure and safeguard the personal safety of personnel, who must also be properly trained and professionally qualified.

3.4 **ADDITIONAL NOTE FOR ATEX PUMPS**

ONLY XR...MU and XRN...MU type pumps can be supplied in ATEX execution. Only these pumps comply with the rules concerning equipment and protective systems for use in potentially explosive atmospheres in accordance with European Directive 94/9/CE dated 23/03/94, known as ATEX directives.

- They meet the requirements of Group II Category 2, making them suitable for use in Zone 1/21 (No danger as a result of **predictable failure**)

- Consequently they are suitable for use in Zone 2/22, resulting classified in Group II Category 3 (No danger **during normal operation**)



WARNING: XR...MU and XRN...MU pumps in ATEX execution are not suitable for use in zone 0/20 !



NOTE: In case of XR...MU and XRN...MU pumps in ATEX execution, in addition to these instructions must be followed also the warnings contained in "Metering pump safety instructions for potentially explosive atmospheres" (addendum to this operating manual)

GB

3.5 SUITABILITY VERIFICATION FOR EFFECTIVE APPLICATION/USE

All pumps are supplied in compliance with requirements established under technical/sales negotiation and defined at time of order.



NOTE: The customer (end user and/or installer) is responsible for checking whether or not the pump is really suitable for the application/use on the plant, this before the installation and subsequent machine start-up.



For ATEX pumps the customer/end user is responsible **to determine the effectiveness of the pump to be used in a given plant**, after having analysed the characteristics of danger existing in the installation location and in compliance with current laws and those issued for safety purposes.

4. TRANSPORT, HANDLING AND STORAGE

4.1 TRANSPORT, LIFTING AND HANDLING



Unless otherwise agreed, the pumps are fixed and packaged in horizontal containers. Make sure that they cannot accidentally tip over during transport or handling and that they are always placed on a flat surface.

Verify that the device used (transpallets, forklift, hoist, etc...) is appropriate for the size and weight of the package/equipment and that any lifting lugs on the machine are screwed down. In environments with temperatures below -20 °C, lifting rings must be used with caution because they could break in low temperatures, causing damage to persons or equipment.



Lifting rings on the pump are sized to bear one-headed pump weight, therefore DO NOT use them to lift multi-headed pumps. For those operations sling base-plate and use lifting ropes. Before removing ropes fix pumps safely to the base. Pay attention, tilting danger !

4.2 STORAGE CONDITIONS

If not used immediately, the pumps should be stored with suitable covers in a temperate, dry, clean, vibration-free and weatherproof environment. Protect from soil moisture by placing the unit on shelves or wooden pallets. If the temperature is below 0 °C, ensure that it does not go lower than -20 °C.

If not specifically highlighted on the package, do not stack packaging, to prevent damage to the machine and to avoid tipping over or falling that can create accidents. Ensure that access of unauthorised persons is not allowed in the storage location and that the floor or shelf can support the weight of the machinery or equipment stored.

Before being put pumps into operation, after being stored for a long period, bring them to a temperate environment in order to stabilise the temperature. In case of storage in extreme conditions, e.g. in sub-tropical or desert climates, take additional safety measures.



Particular storage conditions should be previously reported, in order to provide a suitable packaging.

4.3 DIMENSIONS AND WEIGHTS

Check the dimensions and overall gross weight of the package before handling or lifting.

Unless otherwise agreed, the packaging bears such information (dimensions are expressed in millimetres and weight in kilograms).

5. DESCRIPTION

XR series metering pumps are all single-block type with single hydraulic diaphragm pumphead and spring return mechanism.

They fall into the family of controlled volume alternative displacement pumps. The body single-block contains only one type of oil that carries the dual role of lubricating oil and hydraulic oil.

...MC motors supplied by the customer to OBL to be assembled on the pump
 ...MO pump supplied to the customer WITHOUT a motor.

In case of special execution machines the constructive variations may differ from the above mentioned codes.

5.3 AMBIENT AND DESIGN TEMPERATURE

Unless differently agreed with the customer, the ambient design temperature range "Ta" of XR series pump can be:

-10°C ≤ Ta ≤ +40°C: Standard temperature range for all pump types

-10°C ≤ Ta ≤ +60°C: Standard temperature range for only some pump types

The table below illustrates the maximum allowed temperature of pumped fluid based on pump head material.

	"STANDARD" pumpheads characteristics				
	METALLIC material pumphead	PLASTIC material pumphead			
		PVC (P)	PVDF (S)	PTFE (T)	PP (PP)
HANDLED FLUID Max. temperature	+60 °C	+40 °C	+60 °C	+30 °C	+40 °C



NOTE: During periodic inspection always check that temperatures respect limits here indicated !

The values contained in the table above are equally applicable to each of the allowable ambient temperatures "Ta".

5.4 WORKING PRINCIPLE

XR series hydraulic diaphragm pumps are all with single-block spring return mechanism, coupled to a single hydraulic diaphragm pumphead, made of material (plastic or metallic) chemically compatible with the fluid to be handled. The single-block body incorporates the hydraulic circuit, the transmission reduction gear, the plunger thrust system and the flow rate adjustment system. Contains only one type of oil that carries the dual role of lubricating oil and hydraulic oil.

Plunger works in oil bath without parts subject to wear (without seal) and does not require maintenance over time. Diaphragm fastening system is hermetic and independent from pumphead body fastening. Allows to check diaphragm condition by removing the pumphead, but does not cause oil leakage from the hydraulic system and the consequent failure of the pump.

The pump sectional drawing is usually attached to the present operating manual. In case of missing, see the point "Hydraulic/lubricant oil change" to consult a pumphead sectional drawing or at least contact OBL customer service to receive an updated copy.

They are normally powered by an electric motor through a reduction gear type "endless screw and worm wheel" joined to a duct mechanism. The latter consists of a fixed eccentric and a spring which determines the axial reciprocated movement of the plunger; both the mechanisms are in oil bath.

The motor type differs depending on the type of pump (see "Type of electric motor in relation to pump type").

During the discharge phase the eccentric compresses the spring and, at the same time, forces the plunger to move forward, putting pressure on the oil chamber hydraulic circuit and determining the controlled deformation of the diaphragm, subsequently the fluid in the pumphead moves to the discharge pipeline. During the suction phase is the spring extension which push back the plunger which, creating a vacuum on the hydraulic circuit, deforms the diaphragm again and causes the entrance of fluid in the pumphead.

The check valve on the pumphead controls input and output of fluid from the head, determining flow direction.

A safety valve is installed on the hydraulic circuit to safeguard the pump. If an excess of pressure is detected during operation, exceeding its calibration, the valve opens expelling from hydraulic circuit a quantity of oil equal to the plunger displacement and discharging it into the pump single-block body.

The flow rate adjustment system controls the volume of fluid pumped by varying the plunger return stroke length, standard adjustment is manual with graduate knob and linear vernier.

Alternatively (upon request), an automatic adjustment system can be applied (see "Flow rate adjustment system").

XR series pumps fall into the family of alternative volumetric pumps characterized by adjustable displacement.

The construction material of external components ensures high impact protection. With the exception of pumphead, the external pump surfaces are treated to ensure high protection against corrosion. Metal parts are assembled to ensure correct and proper grounding. XR series pumps are produced only in single pumphead execution.

5.5 THE FLOW RATE

XR series pumps flow rate is not continuous but pulsating, generated by the alternating movement of the plunger (which deforms the diaphragm) and the action of the check valve on the pumphead which determine flow direction (see figure 1). Pump flow rate is adjustable and increases or decreases in direct proportion to the variation of the plunger stroke.

The theoretical flow rate corresponds exactly to the volume described by the movement of the diaphragm. The graphic representation of its behaviour is a straight line whose course is proportional to the adjustment system setting.

The actual flow rate is inevitably lower than the theoretical flow rate, due to the volumetric efficiency of the pump. It varies depending on the type and size of the pump, the nature and viscosity of the liquid to be pumped, working pressure, etc. (see figure 2).

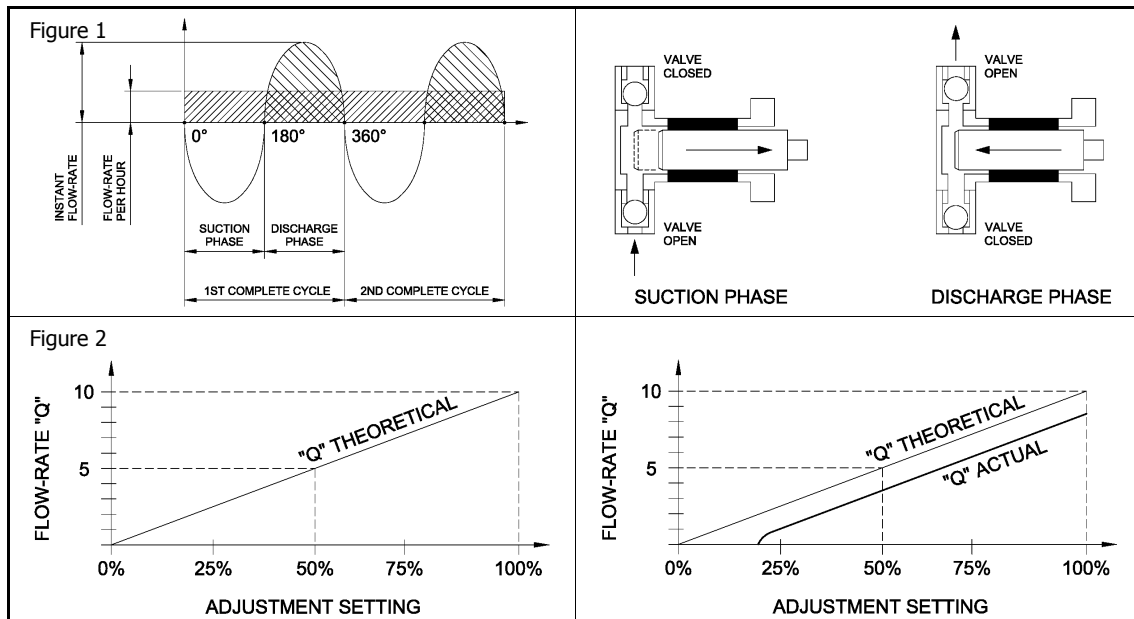

5.6 INTENDED USE

XR series pumps are destined for dosing of non-flammable liquid fluids (acids, alkaline, solvents, etc.) at ambient temperature or heated (see "Ambient and design temperature"), suitable for continuous service (24/24 hours of operation).

They can be used for the following applications:

- chemical and petrochemical plants (auxiliary lines/services);
- thermal power plants (process applications and auxiliary lines/services);
- pharmaceutical industries, food and agribusiness industries;
- water and wastewater treatment;
- in paper mills, on paper production lines;
- detergents production, CIP plants, water treatment plants.



Any other use is considered "IMPROPER USE" and is not allowed. OBL declines all responsibility for any damage to persons or property and any kind of machine guarantee shall be considered void.

5.7 REASONABLY EXPECTED IMPROPER USE

It is improper to use the XR pumps as follows:

- for dosing products differing from those established during technical/sales negotiation and defined at time of order
- in a corrosive and stagnant atmosphere and closed in a poorly-ventilated location
- dosing in pressure without a pressure gauge installed on the discharge pipeline (see "Discharge pipeline - Pressure gauge")
- powered by means of an inverter or other electronic equipment unless explicitly ordered for this use
- with a motor faster than the original one (different polarity)
- in potentially explosive areas unless explicitly ordered for this use



NOTE: It is the responsibility of the customer to verify that the pump is suitable for application/use before installation and start-up. In case of doubt, do not improvise but contact OBL customer service.

5.8 PROHIBITED USE

It is prohibited to use the XR pumps as follows:

- in mining plants (underground);
- immersed in water (as submersible pumps)



IS PROHIBITED use the pumps without protective covers or with safety devices tampered with or damaged



XR...MU and XRN...MU pumps in STANDARD version are not suitable for use in potentially explosive areas !



WARNING: XR...MU and XRN...MU pumps in ATEX execution are not suitable for use in zone 0/20 !

5.9 NOISE

The table below shows the average noise level (lp noise pressure level) emitted by XR series spring return pumps, used within the limits of use and installed in accordance with the instructions contained in the present operating manual.

GB

These average values were detected on the prototype at a distance of 1 metre from the surface of the machine, at a height of 1,6 meters from the working surface and weighted according to curve A.

METALLIC MATERIAL PUMPHEAD		PLASTIC MATERIAL PUMPHEAD	
Pump max capacity (Qmax)	Noise pressure level (lp)	Pump max capacity (Qmax)	Noise pressure level (lp)
Qmax < 150 l/h	< 65 dB(A)	Qmax < 150 l/h	< 65 dB(A)

The employer must implement in the workplace, appropriate technical measures to minimise the risks arising from daily noise exposure and as much as is necessary to ensure and safeguard the health of personnel in the working environment.

5.10 VIBRATIONS

XR pumps do not fall into the category of direct human contact machines. Vibrations produced are not significant when pumps are installed in accordance with these instructions. They are therefore less than 2,5 m/s² of acceleration and are not such as to cause danger situations. If these situations should arise, stop the machine immediately and call the maintenance supervisor.

5.11 TYPE OF ELECTRIC MOTOR IN RELATION TO PUMP TYPE

The XR series pumps family includes pump types **XR** and **XRN**. As STANDARD are assembled with SPECIAL motor; UNIFIED motor (UNEL-MEC) is only installed if required/agreed and the pump code draws this information (see "identification code")

The table below shows the main characteristics of the motors installed in each type of pump

XR - XRN SPECIAL MOTOR (1)			XR ... MU "UNEL-MEC" MOTOR			XRN ... MU "UNEL-MEC" MOTOR		
Size	Frame	Poles	Size	Frame	Poles	Size	Frame	Poles
63	(1)	4	63	B14	4	63	B14	4

(1) Flange and shaft made according to OBL design.



NOTE: XR and XRN pumps STANDARD execution can ONLY be assembled with SPECIAL motor with flange and extended shaft made according to OBL design. The reduction gear endless screw is pinned directly on the motor shaft.

5.11.1 Powering the electric motor with inverter



The pumps must be especially ordered for powering by means of inverter. Otherwise the end user, before their installation, must contact OBL to define new limits of use (Hz, pressure and flow rate) that will be guaranteed only after a new nameplates fixed to the pump.

For a correct use of the pump, the user must comply with the power frequency range allowed by OBL, defined and including from 30Hz to 80Hz. Moreover, IT MUST NOT EXCEED the max operating pressure indicated on the pump nameplate. This value is downgraded and takes into account the maximum operating regime at maximum allowable power frequency (80Hz).

User must also comply with any additional instructions provided by the inverter manufacturer. Solutions for meeting system electromagnetic compatibility (EMC) requirements are the responsibility of the installer.

5.12 TECHNICAL DATA

5.12.1 Pumps type XR

The full range of variables is shown below:

Plunger stroke:	2, 6
Plunger diameter:	15, 20, 30, 38, 48
Pumphead execution:	...A, ...P, ...S, ...T, ...ALL, ...LOY, ...TI, ...SAF
Plunger strokes per minute:	28, 36, 55, 72, 85, 111, 145, 170 (power frequency at 50Hz) 33, 43, 51, 67, 87, 103, 133, 174 (power frequency at 60Hz)
Connections type:	"..." for threaded connections (STANDARD version, no code required), F, FA

5.12.2 Pumps type XRN

The full range of variables is shown below:

Plunger stroke:	2, 6
Plunger diameter:	15, 20, 30, 38, 48
Pumphead execution:	...A, ...P, ...S, ...T, ...ALL, ...LOY, ...TI, ...SAF
Plunger strokes per minute:	28, 36, 55, 72, 85, 111, 145, 170 (power frequency at 50Hz) 33, 43, 51, 67, 87, 103, 133, 174 (power frequency at 60Hz)
Connections type:	"..." for threaded connections (STANDARD version, no code required), F, FA

5.13 FLOW RATE ADJUSTMENT SYSTEM

Flow rate adjustment is continuous and regular and can be carried out either with the pump running or at rest. Anyhow the action it is easier when pump is running, especially in case of large diameter plunger pumps.

5.13.1 Manual adjustment via graduate knob and linear vernier

Standard version provided when it is not specifically requested a particular adjustment system.

The graduated knob from 0 to 10 rotates along a fixed linear vernier sub-divided from 0 to 100%. The line of the fixed vernier is the benchmark to set the adjustment system at desired flow rate percentage value.



5.13.2 Manual adjustment via handwheel with fixed reaction dial

Manual version as an alternative to the "base" version (supplied upon request).

Easy and quick manual adjustment combined with precise, clear and immediate reading. The dial has a percentage scale (from 0 to 100) equipped with a pointer. Fixed reaction dial, differently from "gravitational" type, has the advantage to prevent the adjustment system decalibration during transport or handling due to sudden accelerations, shock or capsizing.



5.13.3 Automatic adjustment by means of actuator

The adjustment system can be automated (upon request) via the application of an electric or pneumatic actuator.

For information on actuator operation consult its specific operating manual.

5.14 INTERNAL SAFETY VALVE ON HYDRAULIC OIL CIRCUIT

All XR pumps are equipped with an internal safety valve in the hydraulic circuit, located below the oil filling plug placed on the upper side of the pump single-block body (see figure 16 in "Hydraulic/lubricant oil change").

This valve protects the pump from pressure excesses generated by the pump itself during operation (discharge closed or blocked).

Therefore, only in this case can be avoided the installation of the external safety valve on the discharge pipeline, if this has been installed to protect the pump.

The safety valve on the discharge pipeline is instead essential when system pressure can rise regardless of pump operation.



It is the responsibility of the user and/or installer to evaluate use or not of an external safety valve.

If during operation of the pump there is an excess of pressure higher than the setting of the internal safety valve, this valve opens and discharges into the pump single-block body a quantity of oil equal to the plunger displacement.

The internal safety valve opening is recognised and evident by means of:

- no pump flow (or at least greatly reduced)
- change of oil level on the oil level plug
- increased noise of the pump (synchronised to the plunger strokes per minute)

6. INSTALLATION AND COMMISSIONING

6.1 INSTRUCTIONS FOR PROPER INSTALLATION

Because of the pumphead check valves work by gravity, it is essential that the housing valve axis must be perfectly vertical for proper pump operation (also to prevent abnormal wear of the valves).

Provide also for installation of the following equipment:

- **a pressure gauge** next the pump. It must be installed before any other accessory installed on the discharge pipeline. Allows to control the actual pump operating pressure (see "Discharge pipeline - Pressure gauge")

- **an external safety valve** immediately after the discharge connection and, in any case, before the ON-OFF valve. Protects the pump and the plant from any accidents caused by excessive pressure (see "Discharge pipeline - External safety valve")
- **a suitable thermal overload device.** It protects motor from overloads and/or short circuits



Protect the pump from product leaks from the plant and/or corrosion phenomena. Avoid to arrange pipeline nor installing accessories directly above the pump. Avoid installation in a closed, corrosive or stagnant location.

GB



For outdoor installations provide proper protection for the pump from direct weathering actions (rain, wind, dust, humidity). Consider the benefits of using a shelter and/or sliding panels. These devices significantly raise the level of efficiency and safety of the whole pump.

Provide adequate free space around the whole pump to allow inspections and/or dismantling. In particular from the pumphead side, in correspondence with the adjustment system and from the motor side (see figure 3).

If the pump is installed outdoors, a shelter is recommended, especially when the pump is equipped with electric actuators or other delicate devices.

Moreover, for pumps with PLASTIC material pumphead also provide:

- appropriate shelter from direct sunlight, to avoid thermal deformation of the pumphead
- periodic controls and/or adjustments of pumphead locking bolt tightening torque
- periodic checks of the handled fluid temperature
- periodic checks of absence of chemical leakages from pumps connections or plant pipelines
- periodic checks of plunger packing. If necessary, replace the packing or adjust the gland nut tightening

6.1.1 Pump and pipeline fixing

Do not install the pump directly on a concrete foundation base. Use a steel baseplate make sure that is stable and well leveled. Fix securely the pump to the baseplate using bolts and washers to ensure a proper load distribution.

The pipelines must be supported independently and their weight must not burden or create tension on the pumphead.

Therefore, besides the baseplate, the pump needs a supporting framework for both its suction and discharge pipelines.

6.1.2 Connecting to plant pipelines

On the discharge pipeline, to remove easily the pump from the plant, provide proper draining pipes near the pumphead.

We suggest to use short fittings to disassemble easily the flanged connections (see figure 4).

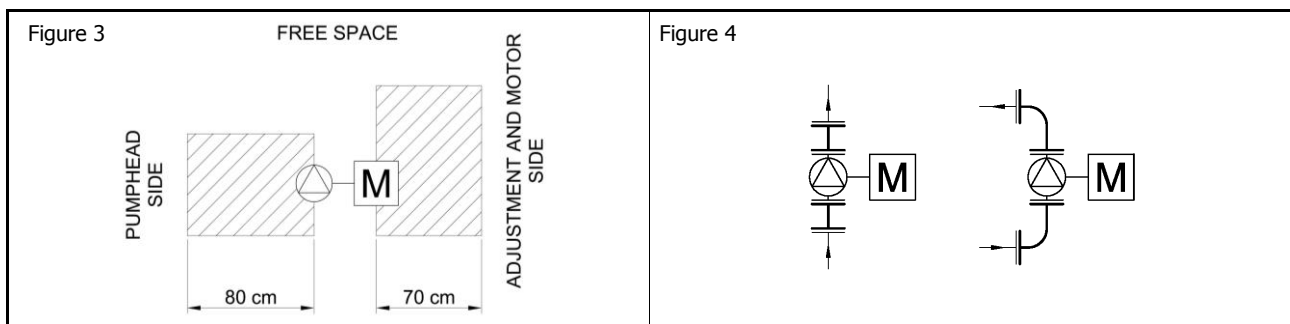

After the pump discharge connection we recommend the use of a cross connection, both to facilitate pump dismantling from the plant and to allow (at a later time if necessary) the installation of a pressure gauge, safety valve, pulsation dampener.

Always verify complete sealing of fittings and pipe flanges, particularly on the suction side pipeline plant.

The entry of suctioned air prevents pump priming.



Before connecting the plant pipelines to the pump connections, it is absolutely necessary flush properly the pipelines with water. Especially the suction pipeline and relevant feed tank. This preliminary flushing is often underestimated by the installer and/or the end user; if this operation is not properly carried out, the pump will become a collector of all foreign matters contained in the suction pipeline and tank, such as weld drops, gasket scraps, soil and other stuff.

6.1.3 Connecting the motor to the mains

The metering pumps are always supplied with the use and maintenance instructions of the electric motor installed.

In addition, for ATEX pumps are also supplied the safety instructions, certification and ATEX conformity declaration.



Before carrying out electrical connections ensure that the mains supply voltage corresponds to that indicated in the nameplate of the motor. Refer to the motor instructions manual and observe relevant provisions.

When for the mains cable connections in used a cable-gland, always choose it correctly according to the type of plant and properly for the type of cable used.

The cable gland should be tightened so that the seal rings keep the necessary pressure:

- to prevent transmission of mechanical stress on the motor terminals
- to ensure mechanical protection (IP degree) of the terminal box



NOTE: Always make the ground connection using the appropriate terminal in the terminal box.

6.2 SUCTION PIPELINE

To ensure a proper and smooth operation of the pump it is essential design correctly the suction pipeline.

Especially when pump is installed higher than the liquid surface, **above tank** (good suction lift required), the factors to consider are:

- the internal diameter of the pipeline
- the overall length of the pipeline
- the arrangement or path of the pipeline

The internal diameter of the suction pipeline must be chosen according to the pump flow rate (see following table A).

Pump connections are sized/designed in excess to cover all applications.

Table A

Suction pipeline size according to maximum pump flow rate					
Max. pump flow rate (Qmax)	Quick fittings	Connections		Flanged connections	
		Threaded	Glued	UNI	ANSI
Qmax < 5 l/h	4 x 6 mm	-	-	-	-
5 l/h < Qmax < 15 l/h	6 x 10 mm	1/4"	-	-	-
Qmax > 15 l/h	-	3/8"	Ø 16 mm	DN 15	1/2" ANSI

6.2.1 Suction pipeline path



The length of the suction pipe must be as short as possible, respecting the dimensions contained in the previous table A.

- for **above tank** installation (good suction lift required), do not exceed a maximum height of 1 metres
- do not exceed a maximum length of 1,5 metres (sum of vertical and horizontal sections).

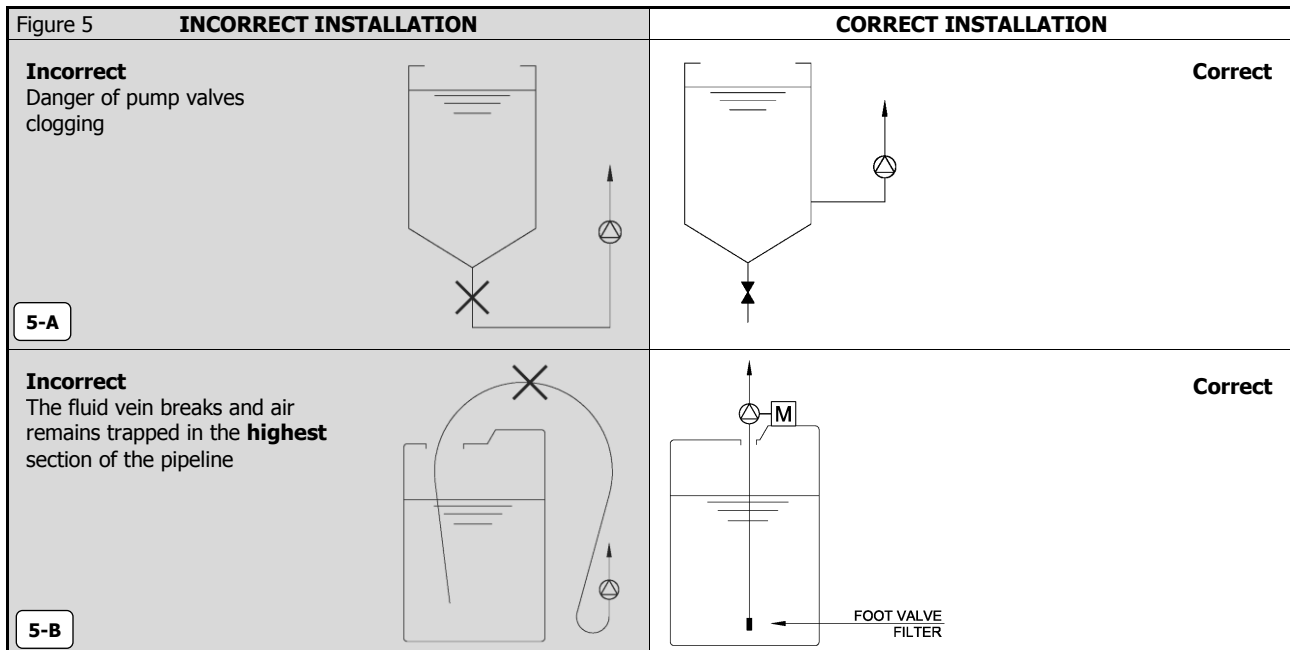
Please refer to figure 5 below for suction pipeline correct arrangement or path.

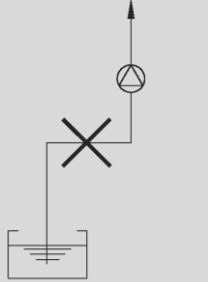
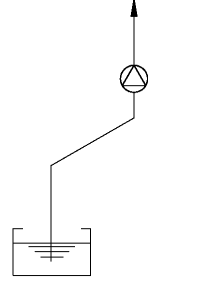
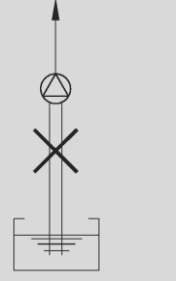
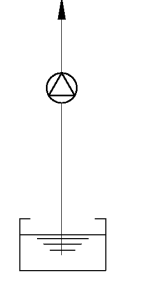
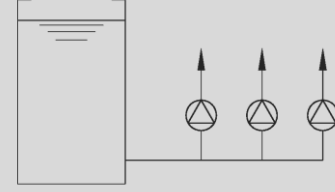
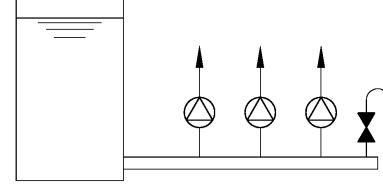
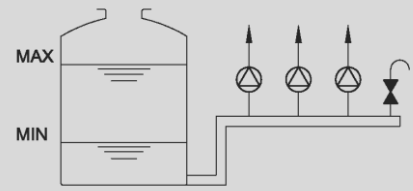
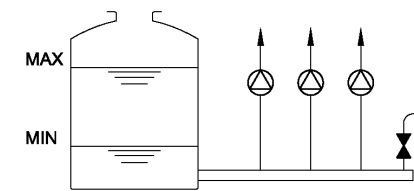
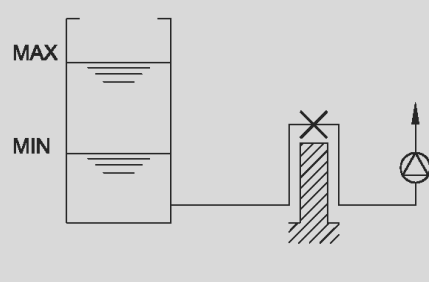
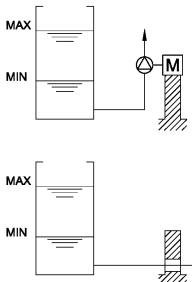
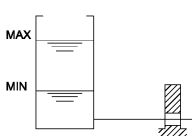
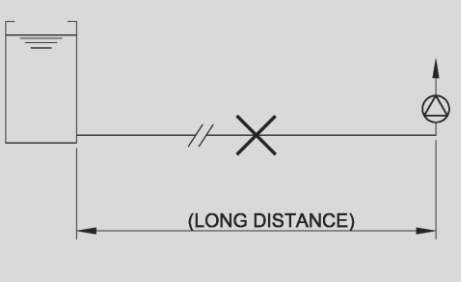
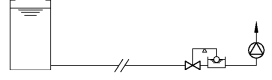
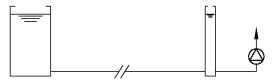

GB

<p>Incorrect The fluid vein breaks and air remains trapped in the horizontal section of the pipeline</p>  <p>5-C</p>	<p>Correct Suction pipeline always uphill</p> 
<p>Incorrect Internal diameter of suction pipeline inadequate (see previous table A)</p>  <p>5-D</p>	<p>Correct Internal diameter of suction pipeline proportioned (see previous table A)</p> 
<p>Incorrect</p>  <p>5-E</p>	<p>Correct</p> 
<p>Incorrect</p>  <p>5-F</p>	<p>Correct</p> 
<p>Incorrect</p>  <p>5-G</p>	<p>Recommended</p>  <p>Recommended</p> 
<p>Incorrect</p>  <p>5-H</p>	<p>Recommended</p>  <p>Recommended</p>  <p>Acceptable</p> 

6.2.2 Suction pipeline for viscous liquids

Pumps for dosing viscous liquid must be specifically ordered for that use.

Where possible, we recommend:

- use pumps with plunger pumphead with a low number of strokes per minute and a large diameter plunger
- in order of importance, use plunger pumps, mechanical diaphragm or, lastly, hydraulic diaphragm pumps
- use stainless steel pumpheads, otherwise with metallic valves or special material

- avoid to install filter in suction pipeline. If essential evaluate its appropriate oversizing (see "Filter on suction pipeline")
- maintain the diameter corresponding to pump connections as the minimum diameter of the suction pipe



As a general rule, always install the pump with suction connection flooded and pay particular attention to the design, arrangement and path of suction pipeline.



ATTENTION: To select a suitable pump the customer must inform us on the plant NPSH available !

Figure 6 shows some installation examples for viscous liquids.

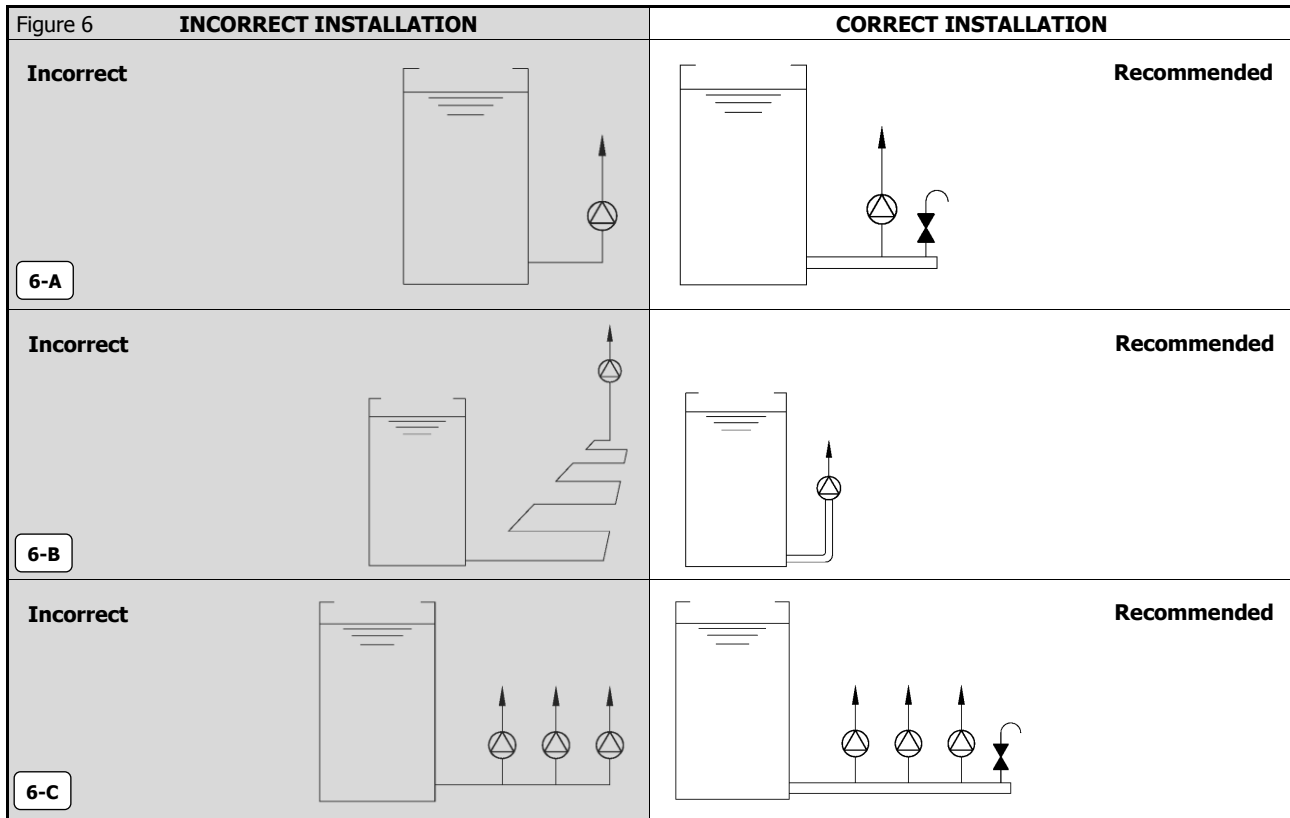

6.2.3 Filter on suction pipeline

To ensure proper pump operation it is important that the product dosed is liquid, homogeneous and clean.

The use of the filter should not affect the suction capacity of the pump. Carefully evaluate the real benefit of using the filter according to the nature and characteristics of the handled fluid. If it is best to use it, properly choose the filter mesh size.

The pump can also convey solids in suspension (non soluble particles) but these are always considered as "disturbing source" elements as they can cause:

- check valves obstruction
- accumulations and/or solidification inside the pumphead
- in case of diaphragm pumps, cutting or rupture of it

As a general rule, **we do not recommend** filter installation in the following case:

- viscous liquid (e.g. polyelectrolyte)
- liquid that coagulates, solidifies or crystallize easily (e.g. caustic soda, ferric chloride)



ATTENTION: A small size filter may impede the suction inlet flow, clogging up the pipeline. Use Y filters (a.k.a. Y strainers) with sizes larger than the diameter of pumps suction side connection.

The filter mesh size and characteristics are linked to the nature of the handled fluid and the pump flow rate. For liquids having viscosity not exceeding 200 cps see the table below.

Max. pump flow rate (Q _{max})	Filter mesh (US standard)	Mesh opening (mm)
Q _{max} < 15 l/h	100	0,152
15 l/h < Q _{max} < 50 l/h	60	0,251
50 l/h < Q _{max} < 100 l/h	50	0,353
Q _{max} > 100 l/h	40	0,422



To avoid suctioning of impurities, especially in dosing liquids with suspensions, do not suction from the bottom of the tank but lift the suction point 10 cm from the bottom (see previous figure 5-A).

Figure 7 shows some examples of filter installation in suction pipeline.

GB

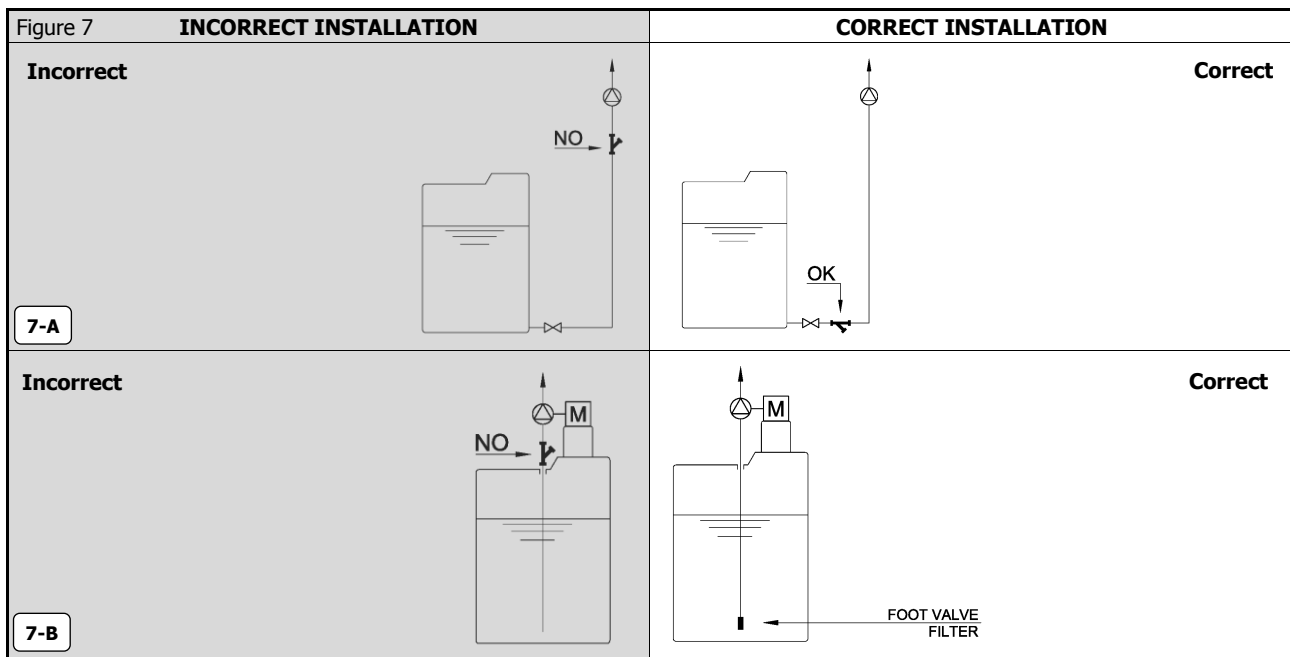

6.2.4 Calibration pot

Allows to evaluate the conditions of the valves and check the actual flow rate of the pump in its real operating conditions and especially during the normal operation of the plant, without interrupting the dosing process.

Have to be installed on the suction pipeline, between the tank and the metering pump (see figure 11).

Is not an essential accessory but it is especially useful in the following cases: dose of hazardous fluids, lack of pulsation dampener on delivery pipeline, difficulty in verifying the pump actual flow rate operating on the delivery pipeline.

6.3 DISCHARGE PIPELINE



Avoid to build the discharge pipeline, or worse to install equipment, directly above the pump.

If the handled fluid free surface of the suction tank is higher than the delivery reservoir this may trigger the siphoning phenomenon (see figure 8). The fluid moves in a spontaneous and uncontrolled manner from the suction tank to the discharge tank, **going through the pump without it being able to control the flow rate in any way.**

To avoid and prevent this phenomenon we suggest to install on discharge pipeline a backpressure valve, or else raise the pipeline so to break the fluid vein. Discharge pressure must be greater than suction pressure by at least 0,3 bar (0,5 bar for small flow rates).

See indications shown in figure 8 for discharge pipeline arrangements.

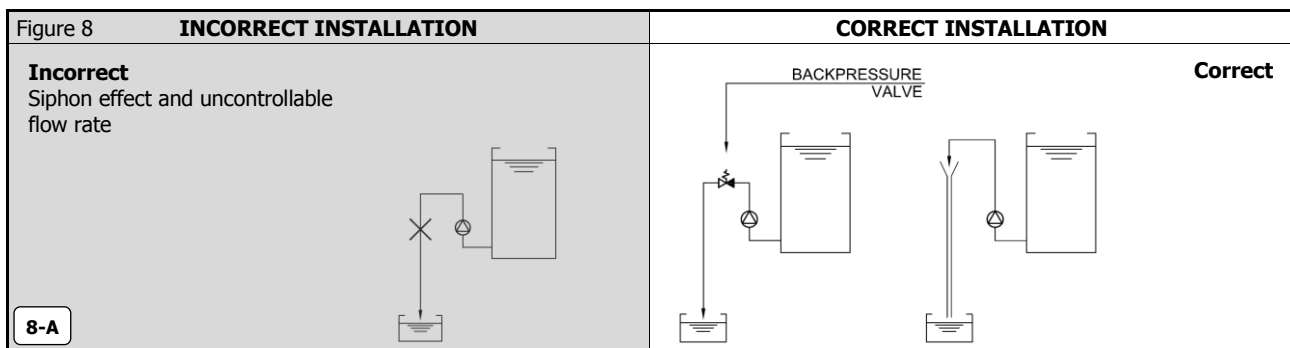

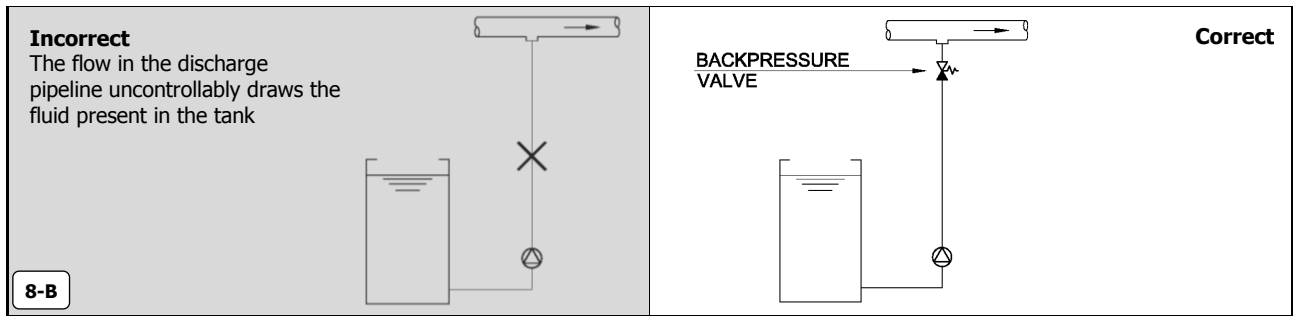

GB

6.3.1 External safety valve

As a general rule, it is always suggested to install an external safety valve on the discharge pipeline, near the pump and before any accessories. This allows to increase the "intrinsic" safety level of the plant.

⚠ The EXTERNAL safety valve on the discharge pipeline is essential when plant pressure can rise quickly, unexpectedly and uncontrollably, regardless of pump operation.

The external safety valve must be installed immediately after pump discharge connection and, in any case, before the ON-OFF valve (see figure 9). The discharge of safety valve must be visible, inspectable and directed back to the suction tank or into a drainage.

Avoid to connect the discharge to the pump suction pipeline (recirculation), **especially on small flow rate pumps**.

Consider the use of an external safety also when dosing in a "free discharge / open flow" plant.

Doing so prevents accident caused by the following risks:

- freezing or solidification of fluid in the pipeline
- obstruction or accidentally squashing of the discharge pipeline (flexible pipes)
- variation of fluid viscosity in relation to the temperature
- when dosing the fluid through the injection nozzles
- other unforeseen risks that may cause quick, uncontrolled rise in pressure

⚠ ATTENTION: XR series pumps are protected by an internal safety valve. To protect the plant we recommend installing an external safety valve on the discharge pipeline.

The external safety valve pressure opening (calibration) must be lower than the internal of the pump (see nameplate).

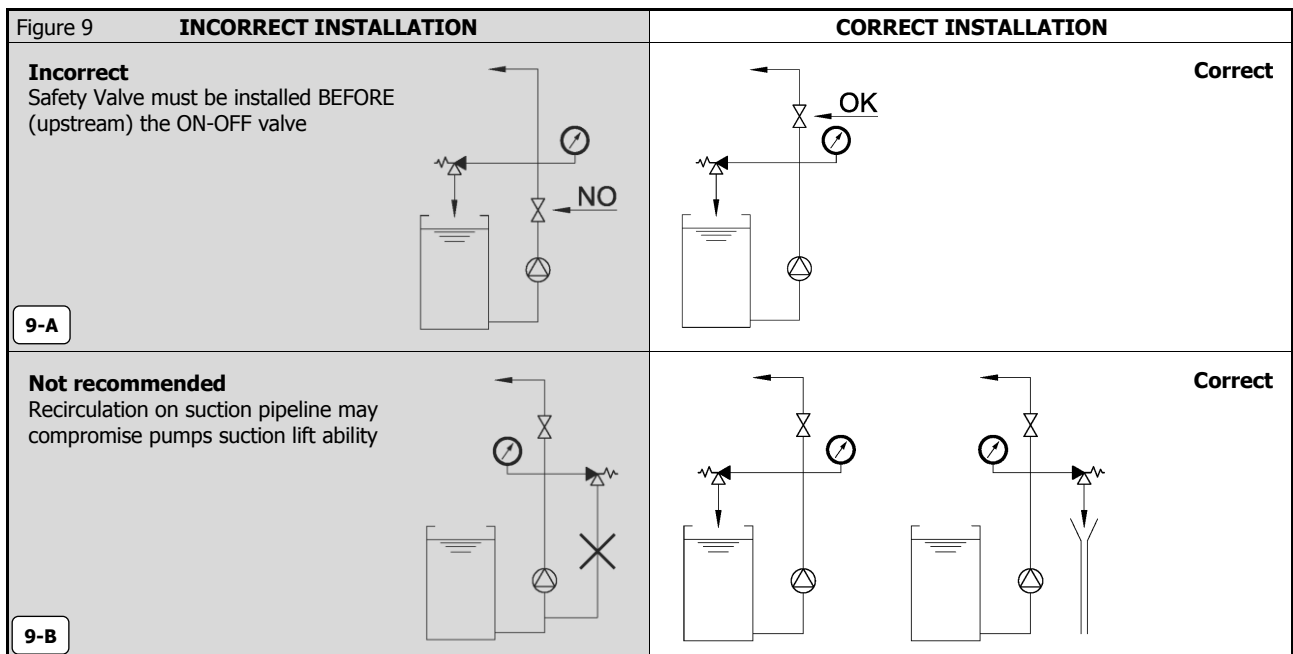

6.3.2 Pulsation dampener

The pulsation dampener is particularly important to improve the dosing process and the pump operation.

There are various benefits obtained with its installation:

- protects the pump from high pressure peaks (fluid hammer) increasing lifespan of pump
- flow rate becomes continuous with a linear flow, increasing the reliability of the dosing process
- significant reduction of vibrations transmitted along the discharge pipeline

- help in reducing noise emitted by the pump



NOTE: If the process require a continuous type flow rate, is essential to install a pulsation dampener.

The pump, by its nature, generates peaks of pressure in the discharge pipeline. Dosing in "closed loop" (eg in static mixers, filter presses, other pressurized piping), although the process does not require constant flow rate/pressure, we recommend installing the pulsation dampener because it absorbs/reduces these peaks by ensuring the correct dosage.

GB

These peaks may in fact cause the opening (discharge) of the external safety valve placed on the delivery pipeline or the internal of the pump (in case of hydraulic diaphragm pump), causing a marked decrease of flow rate and therefore problems to the process.

There are two types of pulsation dampeners on the market:

BOTTLE DAMPENER:

Fluids enters in the dampener and directly compresses the air inside it (without any means of separation).

Dampener volume is approximately 35 times the pump displacement.

Advantages: Less expensive than bladder type dampener. No need for precharge pressure as it self-adjusts.

Disadvantages: Bulkier than the bladder type dampener. Must be installed "vertically" only. Requires periodic maintenance. Must be regenerated periodically by discharging fluid and restoring the air inside.



BLADDER DAMPENER (precharged):

Fluids enters in the dampener and compresses a precharged separation bladder or diaphragm (distension chamber).

Dampener volume is approximately 8 times the pump displacement.

Advantages: More compact than bottle type dampener. Can be installed vertically or horizontally. No need periodic maintenance and not requires to be regenerated as the precharge gas always remains enclosed in the bladder.

Disadvantages: More expensive than the bottle type dampener. It is necessary to know the pump actual operating pressure beforehand to determine the correct bladder precharge pressure. The pump working pressure must always be higher than the precharge pressure.



Figure 10 shows some pulsation dampener examples of installation.

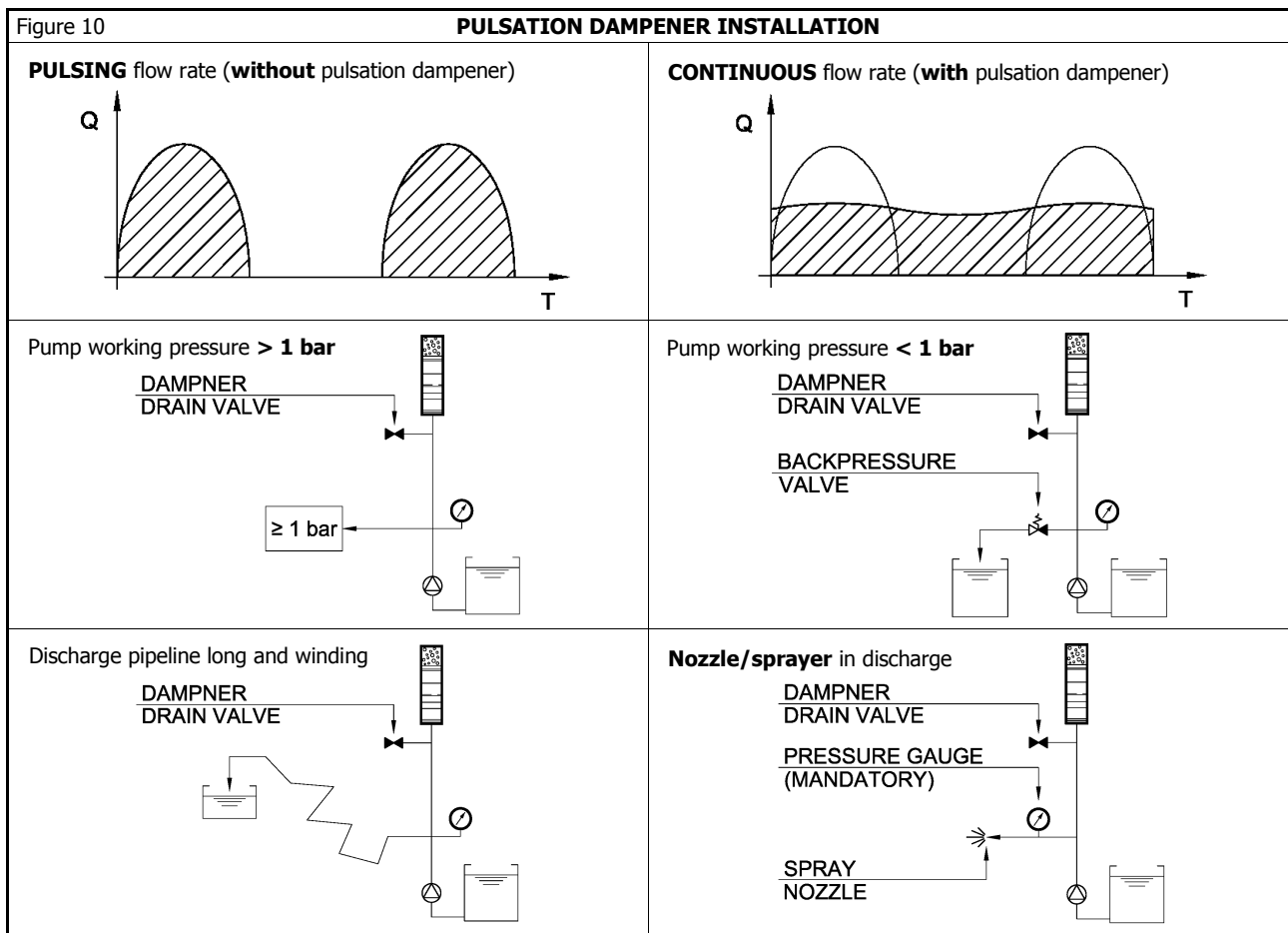

6.3.3 Pressure gauge

Always install a pressure gauge on the discharge pipeline, near the pump, and upstream of any other accessories that may cause pressure increase (see previous figure 10). Allows to control plant conditions and check the pump actual working pressure.



ATTENTION: Knowing the pump actual working conditions in the plant can avoid equipment damage and, especially, can prevent serious risk to persons or property present in the plant !

Consider the use of a pressure gauge also when dosing in a "free discharge / open flow" plant.

Doing so prevents accident caused by the following risks:

- freezing or solidification of fluid in the pipeline
- obstruction or accidentally squashing of the discharge pipeline (flexible pipes)
- variation of fluid viscosity in relation to the temperature
- when dosing the fluid through the injection nozzles
- other unforeseen risks that may cause quick, uncontrolled rise in pressure



ATTENTION: The working pressure must NEVER exceed the maximum allowable pressure indicated on the nameplate, even in case of opening (discharge) of external safety valve. Possible damage to pump or plant !

6.4 EXAMPLE OF PLANT FOR METERING PUMPS

All instructions for proper installation of metering pumps are grouped in figure 11.

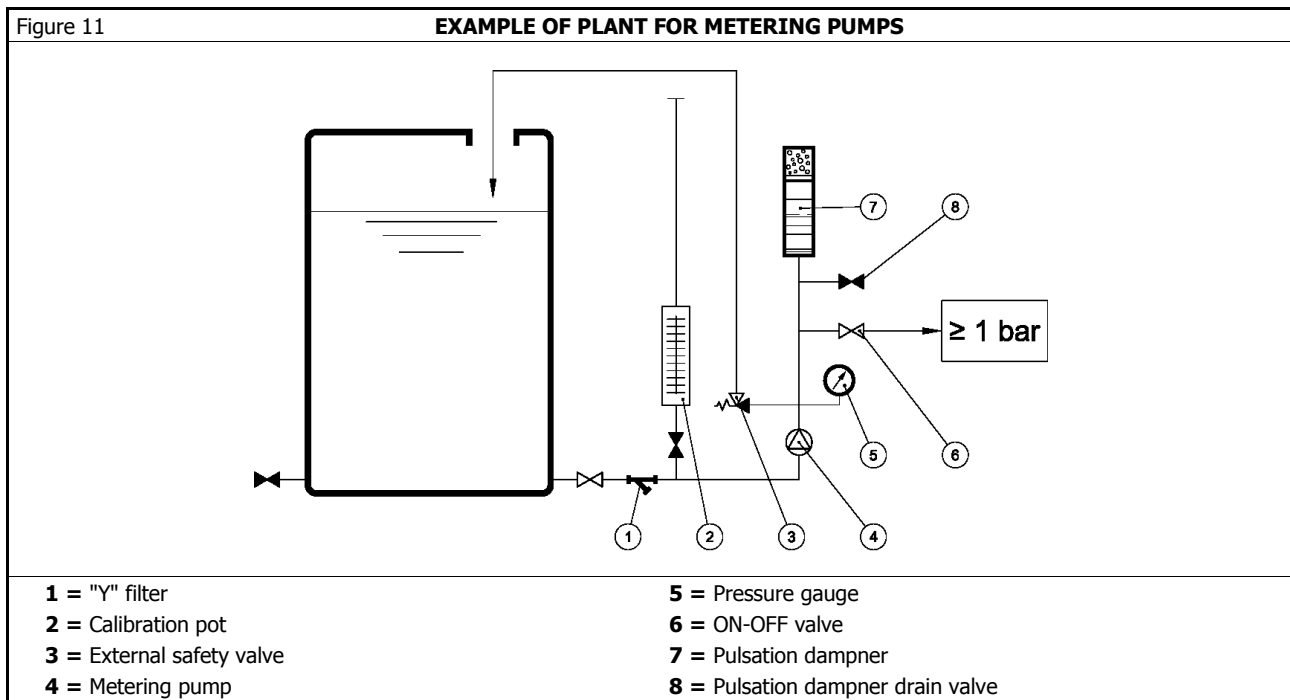

6.5 ELECTRIC MOTOR INSTALLATION

Unless otherwise agreed, the pumps are always supplied complete with an electric motor.

For pumps explicitly ordered without motor ("M0" pump code ending) technical requirements to be met are defined during negotiations.



NON ATEX pumps supplied without a motor (pump code ending in "M0"), it is the end user's responsibility to install a motor with power, rotational speed and coupling type that meet the technical requirements.



For ATEX pumps supplied without a motor (codes ending in "M0"), in addition to the above, it is the end user's responsibility to verify and install a suitable motor for the zone classification and characteristics of flammable substances present in the plant.



OBL DISCLAIMS ALL RESPONSIBILITY FOR DAMAGES TO PERSONS OR PROPERTY CAUSED BY IMPROPER INSTALLATION OF MOTORS.



6.5.1 Pump type XR, XRN



NOTE: XR and XRN pumps STANDARD execution can ONLY be assembled with SPECIAL motor with flange and extended shaft made according to OBL design. The reduction gear endless screw is pinned directly on the motor shaft.

6.5.2 Pump type XR...MU, XRN...MU

The motor (UNEL-MEC compliant) is coupled directly on the pump reduction gear endless screw. Clean motor shaft, lubricate it with oil, then carefully assemble it without shocks and with the utmost caution on the reduction gear endless screw. **Imprecise alignment can cause vibrations with damage of bearings or breakage of motor shaft end.**

6.5.3 Check and change the direction of rotation

At first start-up of the pump, the direction of rotation of the motor should be checked by authorised, experienced and qualified personnel. An arrow on the motor indicates the correct direction of rotation (**counter-clockwise fan side**).



To reverse the direction of rotation of the motor, exchange the two motor power phase cables. Re-check the motor direction of rotation after this activity.

6.6 DESIGN DATA CHECK

Make sure that pump is suitable for working in the actual operating conditions by checking the following:

6.6.1 Environmental conditions

- ambient temperature: check that the actual ambient temperature is consistent with pump characteristics
- altitude: pump suction performances could be influenced by atmospheric pressure. Check the real NPSH(a) available (of the plant) in relation to the NPSH(r) required of the pump.

6.6.2 Installation conditions

- pump installation and operation should only be carried out under the conditions defined at time of order.
- for ATEX pumps: pump classification (group and category) and the temperature class must be suitable for the installation area classification.



Special operating conditions, differing from normal conditions, must always be defined at time of the order, to prevent the pump from working under conditions which may affect proper functioning and compromise safe operation.

6.7 START-UP

Pumps are ALWAYS supplied COMPLETED with oil (hydraulic/lubricant).

To prevent oil spills during transport is mounted a provisional oil filling blind plug (not vented) attached to the working plug (with bleed) through clamp (see figure 12).



ATTENTION: Before starting the pump replace the provisional plug with the working plug !

Carry out the first start-up with stroke adjustment at 20% and with the lowest discharge pressure possible; maintain these conditions for at least 5 minutes. Gradually increase the adjustment up to 100%, then place it in the condition required by the process.

Oil filling is carried out in OBL before the final test. XR series pumps are hydraulic pumps single-block body in which the diaphragm hydraulic circuit and the system of thrust of the plunger using the same oil; see "Hydraulic/lubricant oil change".

During this initial phase, check with a pressure gauge (see "Discharge pipeline - Pressure gauge") the actual pump working pressure. Such value (pointer max. oscillation) must never exceed the maximum pressure value indicated on the pump nameplate.



6.7.1 Checks before start-up

Before starting up the pump check the following:

- that there are no product leakages from pump connections nor pipelines plant, especially along the discharge side

- b) the hydraulic/lubricant oil conditions by means of the oil level indicator, see "Hydraulic/lubricant oil check"
- c) the direction of rotation of the motor and that it is protected as provided for by regulations, see "Electric motor installation"
- d) in case of power supply via inverter, that pump has been purchased for said use and that the actual power frequency range complies with the range of frequency from 30Hz to 80Hz allowed and defined by OBL
- e) correct installation of all possible accessories and their proper operation
- f) that ON-OFF valves along the discharge and suction pipelines are open or closed depending on their function
- g) the liquid to be dosed has not solidified or frozen in pipelines
- h) that is protected from agents such as: sand, corrosive substances, dust and/or fibre, water, mechanical stress and vibrations
- i) that is protected mechanically: indoor installation or outdoor installation considering the damaging effects of weathering, the combined influence of temperature, humidity and condensation



6.7.2 Checks during operation

Once the pump has been started, make sure that operating conditions remain within prescribed limits, in particular check the following:

- a) pump working pressure
- b) motor current absorption
- c) handled fluid temperature, if different from ambient temperature
- d) the entire pump maximum surface temperature (max 40°C for pump reduction gear unit and max 80°C for motor)

Check that pump suitability is maintained whenever changes in operating conditions occur, such as:

- modification of one or more process variables (e.g. working pressure and/or pump flow rate adjustment)
- movement of the pump to a different environment (e.g. from indoors to outdoors)
- dosing of a different fluid from the initial (change of the pump use)
- movement of the pump from a low temperature ambient to another with higher temperature
- change of season or significant climatic variations
- malfunction of possible external safety valve installed on discharge pipeline

6.7.3 Abnormal conditions



Pump must be used exclusively for operating conditions determined at time of order. In case of abnormal operating conditions (high motor absorption, excessive surface temperature, high noise and/or vibrations) promptly inform the maintenance staff/manager.



NO RESPONSABILITY IS ACCEPTED FOR DAMAGE OR INJURIES CAUSED BY DEGENERATION OF MALFUNCTIONS NOT IMMEDIATELY RESOLVED OR REPORTED TO OBL.

6.7.4 Prolonged stops

If a prolonged period of pump stop is foreseen, take the following measures to preserve pump integrity: Cleaning of chemicals, protection from weathering, etc. (see also "General and surface cleaning").

7. ROUTINE MAINTENANCE

Each pump is a reliable, quality product, subjected to a thorough final inspection. In case of malfunction, although pump is installed correctly and operating according to the instructions, do not improvise and immediately contact OBL customer service.



These maintenance suggestions are not intended as "do-it-yourself" repairs. To perform such works, specialised technical knowledge is required and operations are to be performed by qualified personnel.



Interventions on electrical circuits or equipment must only be performed by qualified electricians or, under supervision, by appropriately trained personnel and in accordance with applicable electrical codes.



In case of ATEX pumps, it is necessary pay particular attention not compromise the pumps suitability characteristics to the plant classified area where it is installed.

7.1 OPERATING PRECAUTIONS

All operations must be performed by qualified personnel.

Works on the pump have to be performed after the safety supervisor authorisation, after having verified that:

- a) the power line is disconnected and no parts are energized, including any auxiliaries

- b) any risk of accidental restart has been excluded
- c) handled fluid, present in the pumphead and pipelines, is not pressurized or chemically dangerous
- d) **with pump switched off**, that the ON-OFF valves on the suction and discharge pipelines are closed
- e) pump has been adequately cleaned, when operating in environments exposed to aggressive chemicals

Since the machine object of supply is a product designed and intended for operation in industrial areas, **additional measures must be adopted and assured by the person responsible for the installation, should more restrictive safety conditions be required.**

GB



All maintenance work must be carried out on the pump only when the machine is stopped and disconnected from mains supply (including auxiliary circuits). Maintaining original characteristics over time must be ensured by an efficient maintenance and inspection plan, developed and managed by qualified technicians, taking into account the service and the actual environmental conditions in which it operates.



ATTENTION: During the normal operation of the pump the motor casing temperature can exceed 50 °C. Before performing any test or maintenance verify the complete cooling.

7.2 CONSULTING TECHNICAL DOCUMENTATION

Before starting work, you should consult again this use and maintenance manual, identify the correct sectional drawing of the pump in use and get all the tools and equipment necessary to perform the maintenance or repair works.

NOTE: When the pump has been disassembled, waiting to be reassembled, it is necessary to protect the various components (particularly those inside the mechanism, paying special attention to the working surfaces of the seals) to prevent damage caused by oxidation or accidental impact.



Improper assembly of the sealing components or ball bearings can anticipate their deterioration and result in malfunction and/or overheating.

7.3 PERIODIC OPERATIONS

As a general rule, after the first start-up, close initial monitoring of the machine is recommended to practically define the maintenance plan and also determine the frequency of general inspections and planned maintenance.

Should anomalies or malfunctions occur it is user's responsibility to consider whether maintenance work should be anticipated or not.

7.3.1 Checks of normal operation

During periodic inspections, verify that:

- in case of plunger pumps, there are no leakages of product from plunger packing
- there is no leakage of handled fluid or lubricating oil
- the pump operates properly, without abnormal noises or vibrations
- CE protections (accident prevention) are always fitted



Any defects or irregularities detected during inspection must be promptly solved !

7.3.2 Checks of electrical connections

Power cables, control and grounding cables must not have signs of deterioration and connections must be tight.

7.3.3 Checks of pump connection to plant pipeline

Verify that the connection elements (screws, nuts and bolts, flanges, etc.) are firmly tightened and that relative sealing components are efficient and in perfect condition. During normal operation, pumps can transmit vibrations to pipelines, loosening component connections and causing product leakages. In this case, install a pulsation dampener to reduce pressure peaks, making flow linear and reducing these vibrations.

7.3.4 General and surface cleaning

It is suggested periodically perform the following operations:

- a) if the pump works in a batch dosing system, and the handled fluid tends to coagulate, solidify or crystallize easily, wash the pumphead immediately after each working cycle
- b) prevent/eliminate surface deposits of material that can generate scale and encrustations
- c) remove any accidental presence of corrosive product from the external surface of the pump

- d) verify and be sure that motor ventilation is not impeded. Remove any possible deposits of dust or fibres from the fins and fan cover.

7.3.5 Protection against corrosion

Dosing of aggressive chemicals or operating in exposed environments (acid atmosphere) may expose the pump to corrosion and the risk of premature wear of sealing components. Periodically check:

- that protection covers are always mounted
- that operating windows are always properly closed
- that there is no oil contamination in the reduction gear that could endanger proper lubrication.

7.3.6 Verification of thermal protections



Make sure that motor thermal overload protection is not excluded and is correctly set. Proper selection and setting of overload protection for ATEX pump motors is essential to ensure the temperature class and safety against explosion dangers.

7.3.7 Painting check (if foreseen)

In a corrosive environment, and every time it is needed, it is necessary check periodically that painting does not show deterioration signs which can jeopardize the equipment protection degree.

Repaint the pump every time it is needed in order to protect the external surface from corrosion.

7.3.8 Hydraulic/Lubricant oil check

XR series pumps are always supplied with hydraulic/lubricant oil in the single-block body and ready to run.

Check **daily** that oil level is at the halfway of the oil level indicator and that there are no leaks from dynamic seals or from plugs placed on the pump body. Verify there is no sludge or oil contamination which may compromise the correct lubrication. Replace if necessary (see "Hydraulic/Lubricant oil change").

7.4 RECOMMENDED SPARE PARTS

The most common faults can be solved by having the recommended spare parts in stock, thus avoiding unpleasant wastes of time.

7.4.1 Pumps with PLASTIC material pumphead

This list is indicative; we suggest proceeding as detailed in "Instructions for requesting spare parts".

Position	Component description	SV *	DV *
5	Valve seat	0	2
8	Valve seat O-ring	0	4
9	Valve housing O-ring	0	2
15	Valve (sphere)	0	4
32	Diaphragm	0	1
37	Diaphragm O-ring	0	1
55	O-ring	0	2

NOTE * Suggested quantity: SV= Single Valve pumphead; DV= Double Valve pumphead (standard OBL);

7.4.2 Pumps with METALLIC material pumphead

This list is indicative; we suggest proceeding as detailed in "Instructions for requesting spare parts".

Position	Component description	SV *	DV *
5	Valve seat	0	2
8	Valve seat O-ring	0	4
9	Valve housing O-ring	0	2
15	Valve (sphere)	0	4
32	Diaphragm	0	1
37	Diaphragm O-ring	0	1

NOTE * Suggested quantity: SV= Single Valve pumphead; DV= Double Valve pumphead (standard OBL);

7.5 DISMANTLING, REPLACEMENT AND REASSEMBLY

The most common fault is caused by the directional valve of a dirty, clogged, worn, or even worse incorrectly mounted.



ATTENTION: In the case of dosing anomalies, BEFORE dismantling the hydraulic system (pumphead), verify the actual conditions of pumphead directional valves (see "Valve verify and/or replacement").

7.5.1 Personnel qualifications - Customer service



Entrust the maintenance, repairs and overhauls to experienced and qualified personnel who will restore the original equipment conditions. For information please contact OBL customer service.

7.5.2 Disconnecting electrical connections

Before disassembling the pump always disconnect all the electrical connections. Make sure that any risk of accidental restart of the machine has been excluded.

GB

7.6 VALVE VERIFY AND/OR REPLACEMENT

7.6.1 Pumps type XR-XRN 2.15



NOTE: BEFORE start to disassembly, make sure there is no pressure or high temperature in the pipeline !

Operate with pump OFF. To verify conditions and/or replace the valves proceed as follows (see figure 13):

- release the pump from suction and discharge pipeline, and clean adequately
- remove the valve housing **one at a time** (pos.14; 68 or 69)
- delicately extract the internal components without damaging them (use a plastic tool)
- carefully observe and check the direction of assembly of each components
- check the cleaning, wear and proper direction of assembly of components
- the ball valve (pos.15) MUST be SMOOTH, and not have dents or corrosion signs
- the valve seat (pos.5) must have smooth bevelled surfaces with no dents or signs of wear
- verify the integrity of the O-rings (sealing components) (pos.8; 9; or 55)
- if necessary, replace the damaged components
- reassemble everything exactly as shown in figure 13



ATTENTION: The valve (pos.15) MUST sit on valve seat (pos.5) on the OPPOSITE side of large bevelled surface.

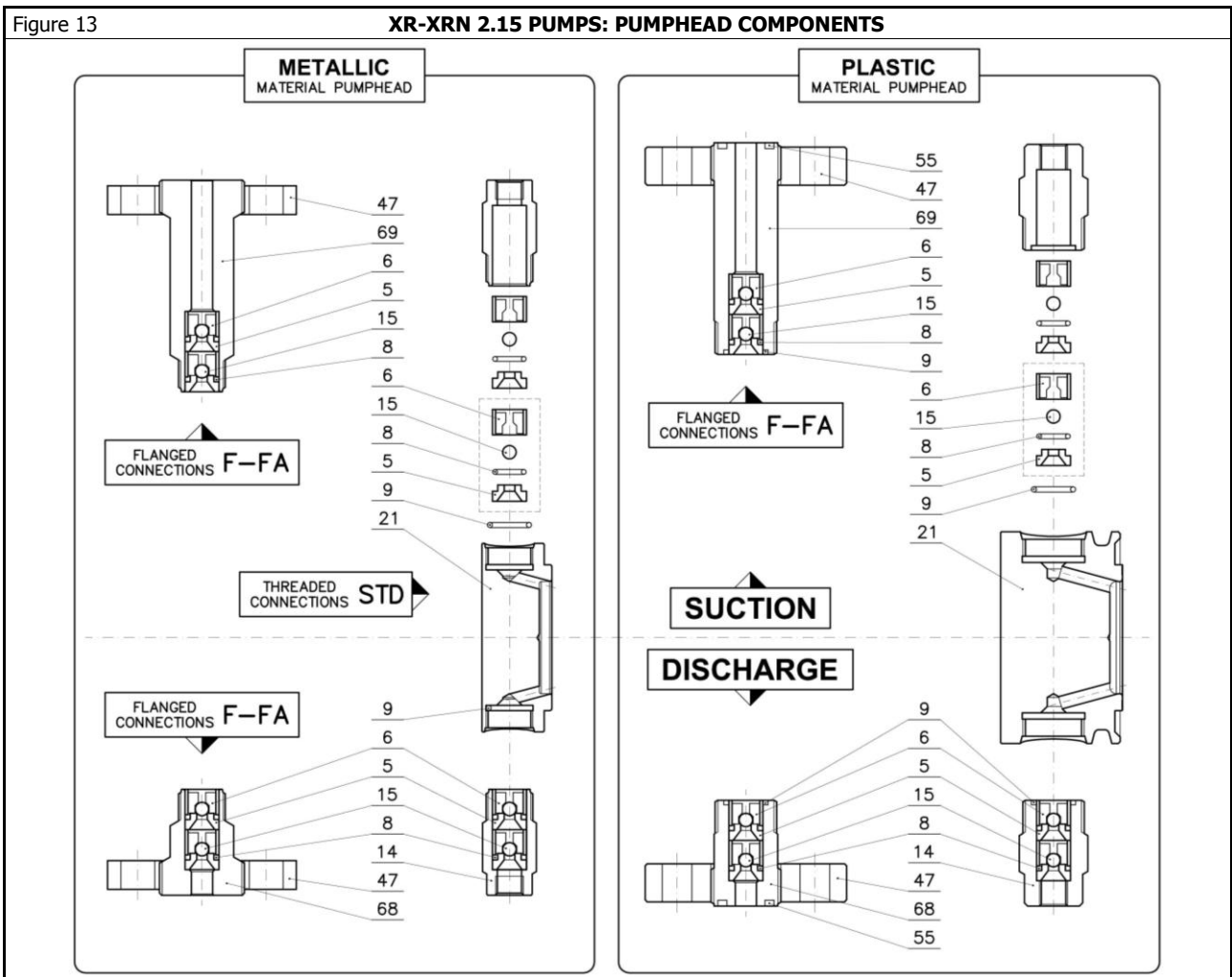

7.6.2 Pumps type XR-XRN 2.30



NOTE: BEFORE start to disassembly, make sure there is no pressure or high temperature in the pipeline !

Operate with pump OFF. To verify conditions and/or replace the valves proceed as follows (see figure 14):

- release the pump from suction and discharge pipeline, and clean adequately
- remove the valve housing **one at a time** (pos.14; 68 or 69)
- delicately extract the internal components without damaging them (use a plastic tool)
- carefully observe and check the direction of assembly of each components
- check the cleaning, wear and proper direction of assembly of components
- the ball valve (pos.15) MUST be SMOOTH, and not have dents or corrosion signs
- the valve seat (pos.5) must have smooth bevelled surfaces with no dents or signs of wear
- verify the integrity of the O-rings (sealing components) (pos.8; 9; or 55)
- if necessary, replace the damaged components
- reassemble everything exactly as shown in figure 14



ATTENTION: The valve (pos.15) MUST sit on valve seat (pos.5) on the OPPOSITE side of large bevelled surface.

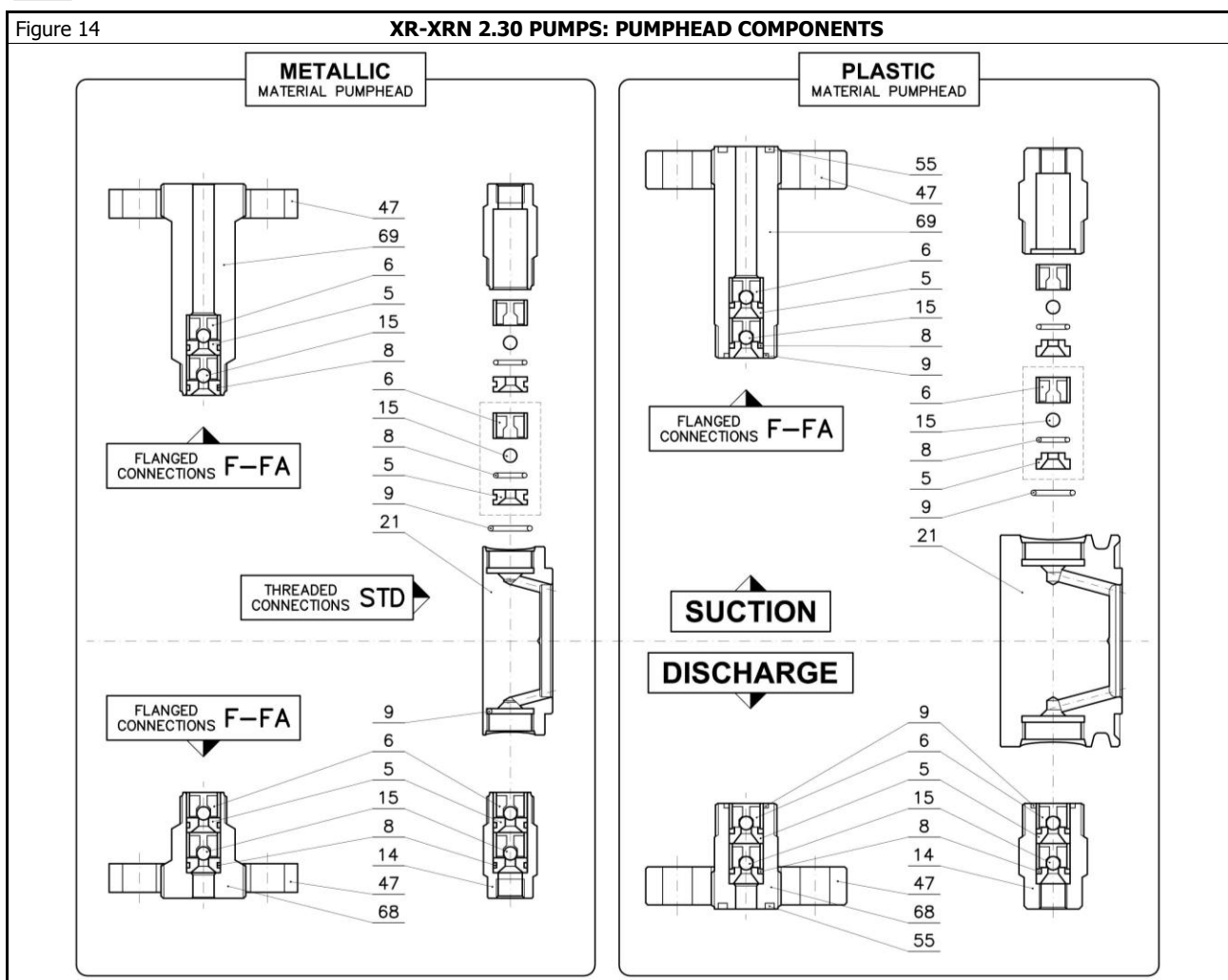

7.6.3 Pumps type XR-XRN 6.20; 6.30; 6.38; 6.48



NOTE: BEFORE start to disassembly, make sure there is no pressure or high temperature in the pipeline !

Operate with pump OFF. To verify conditions and/or replace the valves proceed as follows (see figure 15):

- release the pump from suction and discharge pipeline, and clean adequately
- remove the valve housing **one at a time** (pos.14; 68 or 69)
- delicately extract the internal components without damaging them (use a plastic tool)
- carefully observe and check the direction of assembly of each components
- check the cleaning, wear and proper direction of assembly of components

- the ball valve (pos.15) MUST be SMOOTH, and not have dents or corrosion signs
- the valve seat (pos.5) must have smooth bevelled surfaces with no dents or signs of wear
- verify the integrity of the O-rings (sealing components) (pos.8; 9; or 55)
- if necessary, replace the damaged components
- reassemble everything exactly as shown in figure 15



ATTENTION: The valve (pos.15) MUST sit on valve seat (pos.5) on the OPPOSITE side of large bevelled surface.

GB

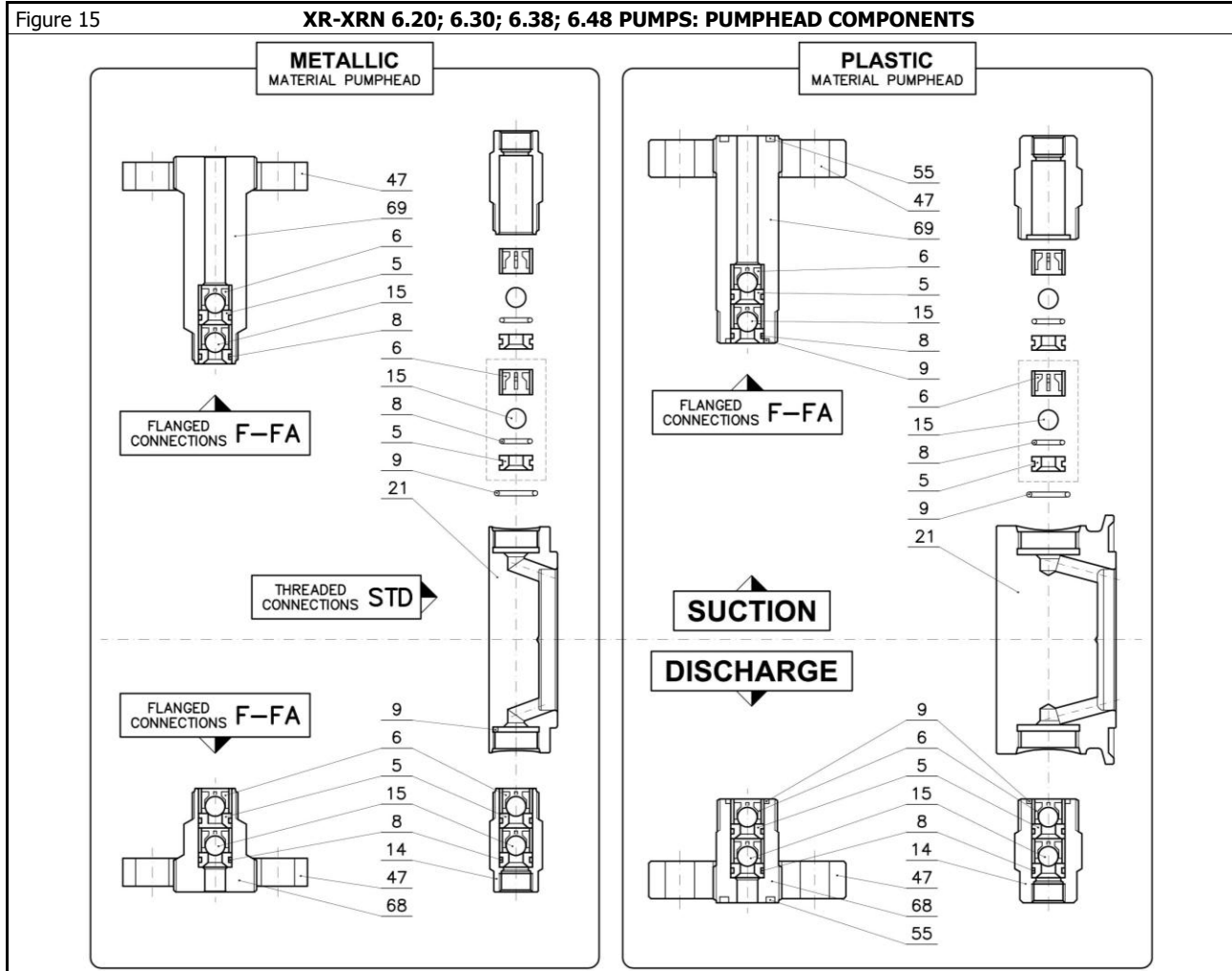

7.7 HYDRAULIC/LUBRICANT OIL CHANGE

XR series pumps are always supplied with hydraulic/lubricant oil in the single-block body and ready to run.



The single-block body contains only one type of oil that carries the dual role of lubricating oil and hydraulic oil.



For standard version pumps replace oil after every 15.000 operating hours; for ATEX pumps every 10.000 hours. In any case replace the oil every 5 years.



NOTE: Chemically contaminated lubricants can cause wear, corrosion and leaking seals. Preferably, always replace all the oil rather than do simple topping.

The oil filling plug (pos.119), the oil level plug (pos.120) and the oil drain plug (pos.121) are all placed on pump single-block body.

The following images allow easy identification of the different plugs.

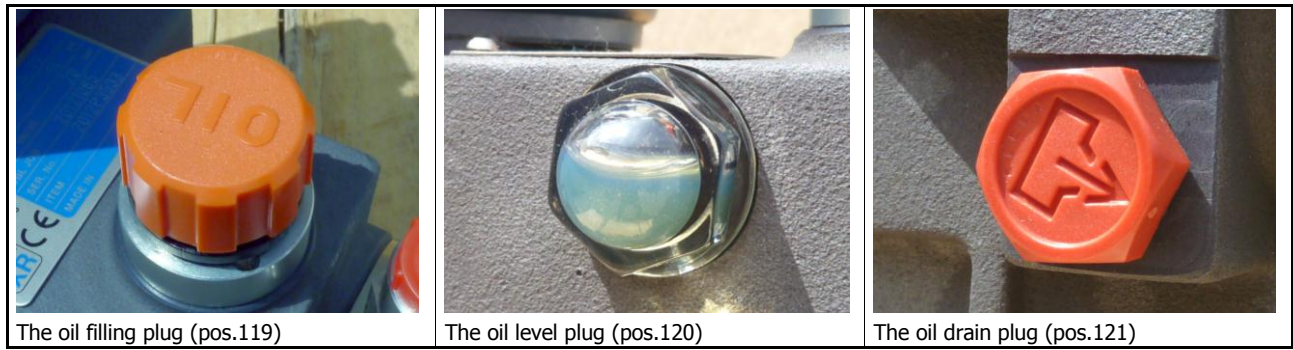

Following table shown quantity and type of lubricant oils suggested:

OIL MAKE	OIL TYPE/NAME
SHELL	OMALA OIL 68
ESSO	SPARTAN EP 68
MOBIL	MOBILGEAR 626
IP	MELLANA OIL 68
AGIP	BLASIA 68

PUMP TYPE	QUANTITY (litres)
XR	0,2
XRN	0,2

! Use lubricating oil different than suggested is permitted only if the characteristics are compatible/equivalent. Use mineral oil for gears with ISO VG 68 viscosity index (68 cSt at 40 °C or 5÷6 °E at 50 °C).

If the oil contains sludge or is contaminated replace it.

Operations for hydraulic/lubricant oil change are the same for all types of pumps.

We suggest, however, reference to following figure 16 during operation.

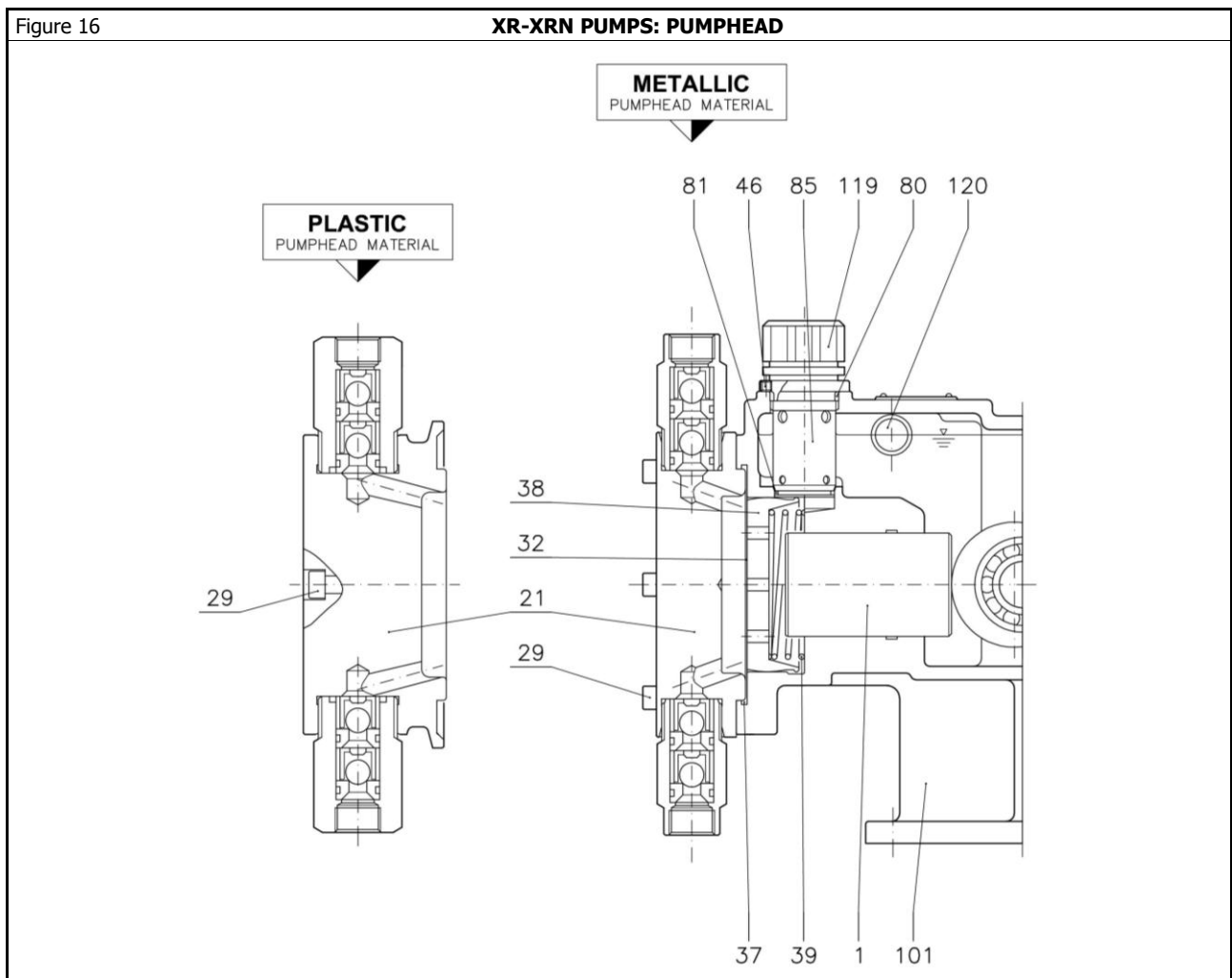

Operate with pump OFF. Proceed as follows:

- remove the oil filling plug (pos.119) and prepare for the removal of the whole safety valve (pos.85)

- remove the locking dowel (pos.46) placed on the top of the safety valve (pos.85), insert a screw into the two opposite holes (see "Diaphragm replacement" figure 19) to get two pins and then unscrew/remove the whole valve. Clean the safety valve **without dismantling into its component parts**, wash and blow with compressed air.



ATTENTION: The internal safety valve is setted and sealed by OBL at the end of final testing. Do not remove the seal, do not dismantle the PSV, do not tamper with or, worse, operate directly on the internal components. These actions could compromise the safety of the plant and of personnel and will also void the guarantee.

GB

- remove the oil drain plug (pos.121) and drain all the hydraulic/lubricant oil from the single-block body
- remove, clean and reassemble the oil level plug (pos.120)
- pour in the oil until it appears in the oil level plug (pos.120). The oil will fill the hydraulic system expelling the air present
- start up the pump with adjustment at 20% and wait in this condition for at least 5 minutes, and in any case until the release of air bubbles stops
- reassemble the safety valve (pos.85) and lock-it with the dowel (pos.46), then reassemble the oil filling plug (pos.119)



NOTE: Before the pump reaches its optimal functioning, wait until the hydraulic oil (just poured into the hydraulic system) bleeds air from the bleed valve and becomes homogeneous. Depending on the diameter of plunger, pumps may require from 1/2 hour (diam. 38÷48) to 1 hour (diam. 15÷30) of operation.

8. SPECIAL MAINTENANCE

The following guidelines cover the most common "special maintenance" operations that only an expert and trained technician can perform. Avoid impromptu operations or attempts, contact OBL customer service for specific information.



These maintenance suggestions are not intended as "do-it-yourself" repairs. To perform such works, specialised technical knowledge is required and operations are to be performed by qualified personnel.



ATTENTION: In the case of dosing anomalies, BEFORE start to dismantling the hydraulic system (pumphead), verify the actual conditions of pumphead directional valves (see "Valve verify and/or replacement").



Appropriate individual safety devices must always be used to ensure and safeguard the personal safety of personnel, who must also be properly trained and professionally qualified.

8.1 TECHNICAL DOCUMENTATION

For "special maintenance" not expected, contact OBL customer care (Tel. +39-02-26919.1, info@obl.it) to receive:

- detailed and focused informations
- specific instructions copy (if available)
- sectional drawing updated copy

8.2 HYDRAULIC SYSTEM MAINTENANCE

XR series pump hydraulic system is equipped with an air-bleed valve, a mechanically actuated oil replenishing valve and a safety valve.

The three valves ensure that the pump has:

- perfect hydraulic balance, allowing operation without any air bubbles (air-bleed);
- impossibility of oil overloading due to clogging or shut-off of the suction pipeline, preventing the danger of impact of the diaphragm against the front wall of the pumphead (mechanical replenishing);
- displacement recirculation in the event of overpressure or shut-off of the discharge pipeline (safety).

Diaphragm working life exceeds 40.000 operating hours. The most likely cause of rupture is usually linked to the nature of the handled fluid (abrasive, solid parts in suspension, etc.).

Plunger works in oil bath without parts subject to wear (without seal) and, except in the event of a diaphragm rupture, never comes into contact with the fluid handled. For this reason it does not require maintenance over time.

8.2.1 Diaphragm condition check

Operations are the same for all types of pumps. Diaphragm fastening system is hermetic and independent from pumphead body fastening. Allows to check diaphragm condition by removing the pumphead, but does not cause oil leakage from the hydraulic system and the consequent failure of the pump.

Operate with pump OFF. Proceed as follows to verify if the diaphragm is broken:

- remove the single-block body internal components in contact with the contaminated oil, clean them properly and verify actual conditions. If necessary, replace the damaged components
- after the single-block body internal components reassembling, assemble the new diaphragm (pos.32) taking attention to insert it into the relative groove
- rub with oil the cut O-Ring (pos.37) and, using a bearing pressed in radial direction, put it back in the groove to lock the new diaphragm (pos.32) (see figure 20)
- pour the new oil until it appears in the level plug (pos.120). Start the pump with adjustable to 20% and wait in this condition for at least 5 minutes, and in any case until the release of air bubbles stops
- reassemble the safety valve (pos.85) and lock-it with the relevant locking dowel (pos.46)
- clean and reassemble the pumphead (pos.21), fasten with locking screws (pos.29); see "Pumphead tightening torque"
- set the adjustment to 100%, refill oil halfway up the level indicator (pos.64). Reassemble the oil filling plug (pos.119)



NOTE: Before the pump reaches its optimal functioning, wait until the hydraulic oil (just poured into the hydraulic system) bleeds air from the bleed valve and becomes homogeneous. Depending on the diameter of plunger, pumps may require from 1/2 hours (diam. 38÷48) to 1 hour (diam. 15÷30) of operation.

8.2.3 Pumphead tightening torque values

The table below shows the tightening torque and locking the pumphead for correct pinching the diaphragm.

The values are purely indicative and refer to temperatures indicated in "Ambient and design temperature".

For assembly of the pumphead, proceed as follows: Pull the head body to the single-block body and hand-tighten the screws.

Following a "cross" tightening scheme, tighten each screw to the torque value specified in the table.

Proceeding clockwise, tighten each screw again (one time at least) until reaching the tightening uniformity.

Screw * (pos.29)	METALLIC pumphead material	PLASTIC pumphead material			
		PVC (P)	PVDF (S)	PTFE (T)	PP (PP)
M 6	7 Nm	3,5 Nm	3,5 Nm	3,5 Nm	3,5 Nm

NOTE * (pos.29) is a screw type **TCCE in AISI-304**



NOTE: For pumps with plastic material pumphead (where applicable) always use the washer (pos.65) to ensure appropriate load distribution, in order to avoid deformations or damage to the pumphead.

8.2.4 Pumps with plastic material pumphead: Recommendations



NOTE: The customer (user and/or installer) must implement these recommendations.

Pumps with plastic material pumphead, compared to the metallic material, require a higher level of attention because of the mechanical characteristics of the material and the nature and/or danger of the chemical being pumped.

Define the most appropriate pumphead tightening torque value, considering also the following factors:

- if the pump is directly exposed to sunlight, or to extreme changes in temperature or if installed near heat sources
- if the handled fluid temperature can cause deformations or the pumphead
- at what actual pressure the pump works and if there is a pulsation dampener installed on the discharge

Also according to the importance and danger of the process, define an appropriate frequency for following checks:

- in case of plunger pumps, verify the plunger packing tightness (check and if necessary adjust the gland nut tightening)
- in case of diaphragm pumps, verify the pumphead leak-tight (check and if necessary adjust the tightening torque)
- verify the presence of any pumphead deformation due to the combined action of temperature and pressure



Any defect or irregularity detected during inspections should be promptly solved !

8.3 BEARINGS REPLACEMENT

Replace the bearings according to actual pump operating conditions:

- **every 20.000 operating hours**, for continuous works at maximum performance
- **every 40.000 operating hours**, for discontinuous works under less severe conditions

To mount the new bearings it is advisable to use a proper sleeve exerting pressure on the coupling ring. In case of shaft coupling, place and support the sleeve on the internal bearing ring. For coupling on the hole, put pressure instead on the outer ring. Make sure the surfaces of the relative seats are lightly oiled to help fitting.

8.3.1 Reassembling

Before reassembling carefully clean internal parts and all components, ensuring above all that seals working surfaces have not been damaged. Pay particular attention while reassembling oil containment seals, especially taking care to preserve the integrity of the seal lips. Restore where needed the layer of grease on the contact surfaces, then proceed with reassembly.



Before restarting the pump, turn the motor fan with a screwdriver, in order to verify the pump mechanism free movement so to have a confirm of the correct reassembling.

8.4 CHANGE OF INTERNAL SAFETY VALVE SET PRESSURE

The set pressure value of the internal safety valve (PSV) is indicated on the pump nameplate, see "Identification nameplate". AVOID as much as possible his changing. When this operation is required, however, it must be performed only by expert, qualified maintenance engineers with highly specialised knowledge. Without said expertise avoid impromptu operations or attempts.



ATTENTION: OBL declines all responsibility for any damage caused by modifications on or tampering with the PSV by non-authorized users. Before operating on the PSV, contact OBL customer service to define new limits of use that will be guaranteed only after a new nameplates fixed to the pump.



ATTENTION: The internal safety valve is setted and sealed by OBL at the end of final testing. Do not dismantle the PSV, do not tamper with or, worse, operate directly on the internal components. These actions could compromise the safety of the plant and of personnel and will also void the guarantee.

If modifying PSV set pressure is required and necessary, contact OBL customer service (Tel. +39-02-26919.1, info@obl.it) stating the following:

- type of metering pump (complete model number)
- metering pump serial number or OBL job n° (as an alternative to the serial number)
- the actual PSV set pressure value (indicated on metering pump nameplate)
- the new set pressure value required

9. OTHER INFORMATION

9.1 FAULTS AND OPERATING PROBLEMS

The tables below are not exhaustive. They contain possible causes and suggested remedy for the most common and recurring faults.

9.1.1 Flowrate lower than expected

POSSIBLE CAUSE	REMEDY
- Air enters from suction pipeline fittings	- Check suction pipeline and tighten the fittings
- Low level of hydraulic/lubricant oil	- Check
- The pump still has the provisional oil filling blind plug (non-vented)	- Replace with the working plug (with bleed) attached to the pump through clamp (see figure 12)
- Air trapped inside the pumphead	- Set, and maintain for a short time, pump flowrate to 100% of adjustment
- Suction head (suction lift) too high	- Reduce the suction head (suction lift)
- Vapour tension too high	- Increase the hydrostatic head on suction side
- Pumping temperature too high	- Increase the hydrostatic head on suction side
- Handled fluid viscosity too high	- Change suction pipeline with one of a larger diameter - Increase the hydrostatic head on suction side
- Suction tank sealed and/or without vent	- Make a vent on top of suction tank
- Suction pipeline clogged or closed by valves	- Check suction pipeline and valves
- Filter on suction pipeline clogged	- Check and if necessary clean the filter
- Pumps valves dirty, worn or reassembled in wrong direction	- Check the cleaning, wear and proper direction of assembly of pump valves
- Pump working pressure exceed internal safety valve pressure setting	- Check if the safety valve opens or not
- Safety valve pressure setting is too low	- Check if the safety valve opens or not
- Wrong flowrate adjustment setting	- Check and if necessary correct the adjustment setting

9.1.2 Flow rate irregular or higher than expected

POSSIBLE CAUSE	REMEDY
- Suction pressure higher than discharge pressure	- Increase the discharge pressure at least 0,3÷0,5 bar (3÷5 metres) respect to the suction pressure



- Backpressure valve stuck in open position because of dirty or set pressure is too low	- Verify backpressure valve conditions
- Pump valves jammed in open position	- Verify pump valves, dismantle and clean them carefully

9.1.3 **Overheating of pump body and/or motor**

POSSIBLE CAUSE	REMEDY
- Incorrect electrical connections	- Check electrical connections and motor power consumption
- Actual pump working pressure higher than the maximum allowed	- Install a pressure gauge on the discharge pipeline to verify and reduce actual pump working pressure
- Discharge pipeline may have reduced section causing a drastic increase of working pressure	- Reduce the working pressure or install a pulsation damper to stabilize pressure (avoid the peaks)
- Plant pipelines transmits stress to the pump connections	- Verify and if necessary correct the pipeline connections to the pump
- Discharge pipeline clogged or valve closed	- Check the discharge pipeline
- Backpressure valve set pressure is higher than maximum allowed	- Check the backpressure valve
- Low level of lubricant oil or chemically contaminated	- Check and if necessary change the lubricant oil

9.2 **DISCONNECTION FROM THE PLANT AND SENDING TO OBL FOR MAINTENANCE**

BEFORE shipping, always contact OBL customer service and operate as indicated in "Mandatory instruction for returning goods in OBL".

9.3 **STORAGE FOR LONG PERIODS**

For long term storage (more than 6 months), in addition to those described in "Storage conditions" it is necessary to observe the following precautions:

- Before storage: protect unpainted surfaces with long-term anti-corrosion products
- Verify the conditions about every 6 months. At the first sign of corrosion clean and re-apply anti-corrosion products



Particular storage conditions should be previously reported, in order to provide a suitable packaging.

9.4 **DISPOSAL AND DEMOLITION**

The pumps are made of metal and plastic parts.

It is the end user's responsibility to respect the procedures and regulations in the country of operation, regarding disposing correctly of waste resulting from maintenance (consumption material) or the demolition of equipment.

"Waste" means any substance or object that the holder intends, or requires to discard. Waste are classified according to their origin in "urban waste" and "special waste" and also according to their harmfulness, in "dangerous waste" and "non-dangerous waste".



Waste deriving from pumps maintenance or demolition, only if properly cleaned, are classified as "special waste". Otherwise they are to be considered as "DANGEROUS special waste".



Is forbidden to mix "special waste" with "urban waste", especially "dangerous" with "non-dangerous waste"

Briefly summarized:

- there is an obligation not to dispose of "special waste" as "urban waste"
- "special waste" must be subject of separate collection using public or private collection systems according to local laws (transferred to appropriate collection points approved)
- according to its use, the equipment may contain dangerous substances. Improper disposal may have adverse effects on human health and the environment
- fines are provided in case of misuse or improper waste disposal



It is strictly forbidden to dispose of waste in the sewage system or leave waste in the environment. Contact your local waste disposal service to receive adequate and correct information.

10. **MANDATORY INSTRUCTION FOR RETURNING GOOD IN OBL**



ATTENTION: OBL reserves the right to reject any goods received without previous notice !

In the interest of the customer/user, we kindly invited the SENDER to ALWAYS contact OBL customer service (Tel +39-02-26919.1, service@obl.it) to agree the convenience or otherwise of sending/repair.

Following directions apply to ANY reasons for returning goods to OBL, e.g.:

- Servicing, maintenance, upgrading, retrofitting;

- Funcional/Performance check, checking of Warranty applicability;
- BRAND NEW goods return and application for credit note due to wrong ordering;
- other...

10.1 **MANDATORY DIRECTIONS FOR SENDER**

- **BEFORE** shipping anything to OBL, **ALWAYS** contact OBL customer service (+39-02-26919.1, service@obl.it) to have **RA number** (authorisation number to return goods to OBL), returning informations **and related forms**;
- **PLUNGER pumps: Remove the entire pumphead, the plunger must remain "exposed"**. Do not send the "plunger packing", since it is highly polluted by the fluid handled;
- **DIAPHRAGM pumps: Only remove the valve units from the pumphead, DO NOT remove the pumphead body**;
- **In general: ALWAYS** remove from EACH equipment any residual of products. To guarantee safety at work for OBL's staff disassemble and clean each individual component wetted and attach them in a separate package;



ATTENTION: Parts considered "hazardous" for improper cleaning will be replaced and quoted as a new spares

- **Insert in the packing** (courier often keep them): a copy of shipping documents and for each equipment, copy of duly fill-in declaration of conformity for shipping and of Material Safety Data Sheet of pumped/handled fluid;
- Pack the good in a proper manner to avoid damage during transit, and clearly indicate **RA number** on packing;
- Ship goods **DAP Segrate** (DDP Segrate for goods coming from countries outside the EC) always with shipping document indicating relevant **RA number** to: OBL S.r.l. Via Bruno Buozzi n°1 - 20090 Segrate (MILANO) ITALY.



NOTE: The sender is aware of the penalties provided for unfaithful statements and falsity in acts. Is also responsible for damage to persons or property resulting from such actions.

10.2 **CLEANING OF EQUIPMENT**

Take appropriate and adequate protection measures to ensure and guarantee safety at work for the operator.

In the case of machines working with chemicals product (e.g. acids) pay the greatest attention to the most appropriate choice of liquid to do this operation properly and safely, and also preserve the integrity of the machinery.



Present information does not replace any existing standard or requirement for safety. OBL declines any responsibility for damages to persons or property.

10.3 **GOODS REJECTED TO SENDER**

If OBL receives the goods:

- Not properly cleaned (and/or without declaration of conformity for shipping filled-in)
- PUMPS: With pumphead not properly cleaned and dismantled
- WITHOUT an RA number (authorisation number) on shipping documents and/or on the packing itself
- With chemicals in the packing



They WILL NOT be accepted (nor service will be done) and will be sent back at sender's expenses !

11. **OVERALL AND SECTIONAL DRAWINGS**

Considering the importance of such documents (subject to changes or updates) we believe that they should not be an integral part of the present instructions manual. Unless agreed otherwise with the customer, they are therefore manually attached (latest edition).

12. **CE CONFORMITY DECLARATION**

XR series hydraulic diaphragm metering pumps are comply to requirements of following European Directives (latest edition):

- Machinery Directive
- Low Tension Directive
- Electromagnetic Compatibility Directive

The CE conformity declaration is an integral part of this operating manual (see next page).



POMPE DOSATRICI

METERING PUMPS



GB

OBL s.r.l. - Via Kennedy, 12 - 20090 Segrate - MILANO - ITALY
Tel. +39 02 26919.1 - Fax +39 02 2133893 - E-mail: info@obl.it

DICHIARAZIONE DI CONFORMITÀ CE (Allegato IIA - 2006/42/CE) CE CONFORMITY DECLARATION (Attachement IIA - 2006/42/CE)

Modello / Model / Modèle / Modell / Modelo / Model / Model / Typ / Model / Malli / Μοντέλο

POMPE DOSATRICI SERIE
METERING PUMPS SERIES

XR

IT DICHIARAZIONE DI CONFORMITÀ CE

Noi, OBL s.r.l., MILANO ITALIA, dichiariamo sotto la nostra unica responsabilità che il prodotto cui questa dichiarazione si riferisce, è conforme alle seguenti direttive e successive modifiche:

- Direttiva Macchine 2006/42/CE;
- Direttiva Bassa Tensione 2006/95/CE;
- Direttiva Compatibilità Elettromagnetica 2004/108/CE.

GB CE CONFORMITY DECLARATION

We, OBL s.r.l., MILAN ITALY, declare under our sole responsibility that the product relevant to this declaration complies with the following directive and subsequent modifications:

- Machinery Directive 2006/42/EEC;
- Low Voltage Directive 2006/95/EEC;
- Electromagnetic Compatibility Directive 2004/108/EEC.

FR DECLARATION DE CONFORMITE CE

Nous, OBL s.r.l., MILAN Italie, déclarons sous notre seule responsabilité que le produit auquel cette déclaration se rapporte, est conforme aux suivantes directives et successives modifications:

- Directive Machines 2006/42/CEE;
- Directive Basse Tension 2006/95/CEE;
- Directive Compatibilité Electromagnétique 2004/108/CEE.

DE EU-KONFORMITÄTSERKLÄRUNG

Wir OBL s.r.l., MAILAN ITALIEN, erklären unter unserer Verantwortung, dass unser Produkt, auf das sich diese Erklärung bezieht, den folgenden EU-Richtlinien und deren Änderungen entspricht:

- Maschinenrichtlinie 2006/42/EWG;
- Richtlinie Niederspannung 2006/95/EWG;
- Normen über die Elektromagnetische Verträglichkeit 2004/108/EWG.

ES DECLARACIÓN DE CONFORMIDAD CE

Nosotros, OBL s.r.l., de MILÁN ITALIA, declaramos bajo nuestra sola responsabilidad que el producto al que se refiere esta declaración, cumple con las siguientes directivas y sucesivas modificaciones:

- Directiva de Máquinas 2006/42/CEE;
- Directiva de Baja Tensión 2006/95/CEE;
- Directiva de Compatibilidad Electromagnética 2004/108/CEE.

PT DECLARAÇÃO DE CONFORMIDADE CE

Nós, OBL s.r.l., MILÃO ITALIA, declaramos sob nossa inteira responsabilidade que o produto ao qual se refere esta declaração se encontra de acordo com as seguintes directivas e sucessivas modificações:

- Directivas Máquinas 2006/42/EEC;
- Directivas Baixa Tensão 2006/95/EEC;
- Directivas Compatibilidade Electromagnética 2004/108/EEC.

NL EG-VERKLARING VAN OVEREENKOMST

Wij, OBL s.r.l., MILAAN ITALIË, verklaren voor onze uitsluitende verantwoordelijkheid dat het product waarop deze verklaring betrekking heeft, in overeenstemming is met de volgende richtlijnen en navolgende wijzigingen:

- Machinerichtlijn 2006/42/EEG;
- Laagspanningsrichtlijn 2006/95/EEG;
- Richtlijn Bestendigheid tegen Elektromagnetische Storingen 2004/108/EEG.

DA CE-OVERENSSTEMMELSE ERKLÆRING

Vi, OBL s.r.l., MILANO ITALIEN, erklærer os ansvarlige for at produktet, som denne erklæring henviser til, stemmer overens med følgende direktiver og påfølgende modificeringer:

- Maskindirektiv 2006/42/EEC;
- Lavspændingsdirektiv 2006/95/EEC;
- Direktif for Elektromagnetisk Forenelighed 2004/108/EEC.

SV EG ÖVERENSSTÄMMESEFÖRKLARING

Vi, OBL s.r.l., MILANO ITALIEN, förklarar under eget ansvar, att produkten, till vilken denna förklaring hänför sig, överensstämmer med följande normer och deras respektive ändringar:

- Norm för Maskiner 2006/42/EEC;
- Norm för Lågspänning 2006/95/EEC;
- Norm för Elektromagnetisk Förenlighet 2004/108/EEC.

NO CE-OVERENSSTEMMELSESERKLÆRING

Vi, OBL s.r.l., MILANO ITALIA, erklærer under eget ansvar at produktet som omfattes av denne erklæringen er i overensstemmelse med følgende direktiver og senere endringer:

- Maskindirektivet 2006/42/EU;
- Lavspenningsdirektivet 2006/95/EU;
- Direktivet vedr. Elektromagnetisk Kompatibilitet 2004/108/EU.

FI YHDENMUKAISUUSTODISTUS

OBL s.r.l., MILANO ITALIA, vakuuttaa omalla vastuullaan, että tässä todistuksessa mainittu tuote vastaa seuraavien direktiivien ja niihin tehtyjen muutosten vaatimuksia:

- Laitedirektiivi 2006/42/EU;
- Pienjännitedirektiivi 2006/95/EU;
- Direktiivi 2004/108/EU joka käsittelee sähkömagneettista yhteensopivuutta.

EL ΔΗΛΩΣΗ ΣΥΜΜΟΡΦΩΣΗΣ CE

Εμείς η εταιρία, OBL s.r.l., MILANO ITALIA, δηλώνουμε υπεύθυνα ότι το προϊόν αυτό είναι κατασκευασμένο σύμφωνα με τις παρακάτω προδιαγραφές και τις τροποποιήσεις τους:

- Προδιαγραφές μηχανμάτων 2006/42/EE
- Προδιαγραφές χαμηλής τάσης 2006/95/EE
- Προδιαγραφές ηλεκτρομαγνητικής συμβατότητας 2004/108/EE

Persona autorizzata a costituire il fascicolo tecnico / Person authorized to compile the technical file / Personne autorisée à constituer le dossier technique / Person bevollmäktigt de teknischen Unterlagen zusammenzustellen / Pessoa facultada para elaborar el expediente técnico / Pessoa autorizada a compilar o processo técnico / Persoon die gemachtigd is het technisch dossier samen te stellen / Person bemyndiget til at udarbejde det tekniske dossier / Person som är behörig att ställa samman den tekniska dokumentationen / Autoriseret til å kompilere den tekniske dokumentasjonen / Henkilö on valtuutettu kokoamaan teknisen erittelmän / Πρόσωπο εξουσιοδοτημένο να καταρτίσει τον τεχνικό φάκελο

Stefano COPELLI

presso / at / à / bei / en / em / bij / ved / vid / på / at / στο

OBL s.r.l. - Via Kennedy, 12 - 20090 Segrate - MILANO - ITALY

Nome e posizione del dichiarante / Name and position of issuer / Nom et fonction de l'émetteur / Name und position des Ausstellers / Nombre y cargo del expedidor / Nome e posição do emissor / Naam en functie van de verstrekker / Naam og adresse på udsteder / Namn och befattning på utställare / Utsteders navn og stilling / Jukaisijan nimi ja asema / Όνομα και θέση εκδότη

Dieter SAUER
President

Segrate (MILANO) ITALY: 16.07.2012

Firma del dichiarante / Signature of issuer / Signature de l'émetteur / Unterschrift des erstellers / Firma del expedidor / Assinatura do emissor / Handtekening van de uitgever / Udsteder, underskrift / Utsteders signatur / Utgårdarens namnteckning / Ilmoituksen antajan allekirjoitus / Υπογραφή εκδότη