



USE AND MAINTENANCE MANUAL

R

RH

CE

English

Doc. N° U5134 UT	Rev. 0	Lang. EN	1st Issue – Jan 2017 -
Prepared C.V.C.	Checked C.V. Carbone	Replace	-

Rev.	Revised sections	Checked	Date

	TRANSLATION OF ORIGINAL INSTRUCTIONS
	<p>ATTENTION: Industrial machinery not intended for use by not professional operators. These instructions are intended for qualified personnel.</p>

OBL JOB No.					
CUSTOMER					
CUSTOMER ORDER No.					
METERING PUMP TYPE					
ANNEXES					
ITEM/S					
SERIAL NUMBER/S					

TABLE OF CONTENTS

1	CE MARKING	3
1.1	Plate position on the machine	3
1.2	PUMP IDENTIFYING CODE	4
2	DECLARATION OF CONFORMITY	5
3	INTRODUCTION	6
4	REGULATORY FRAMEWORK	7
5	PRESENTATION	7
5.1	INSPECTION AND GUARANTEE	7
5.1.1	Inspection	7
5.1.2	Guarantee	7
5.2	RECEIVING INSPECTION	8
5.3	SUPPLY CONDITIONS	8
5.3.1	OVERALL AND SECTIONAL DRAWINGS	9
5.4	PERSONNEL RESPONSIBLE FOR MACHINE OPERATION.....	9
5.4.1	"Operator" personnel	9
5.4.2	"Mechanical Maintenance" personnel	9
5.4.3	"Electrical Maintenance" personnel.....	9
6	TECHNICAL DATA	10
6.1	GENERAL DATA	10
6.1.1	Noise	10
6.1.2	Vibrations	10
6.2	DIMENSIONAL DATA.....	10
6.3	ELECTRIC MOTOR AND POWER	10
6.4	TECHNICAL DATA BY PUMP TYPE	12
6.5	ENVIRONMENTAL AND DESIGN TEMPERATURE	13
7	TRANSPORT - STORAGE	13
7.1	TRANSPORT, LIFTING AND HANDLING	13
7.2	STORAGE CONDITIONS	14
8	COMMISSIONING	14
8.1	PRELIMINARY INSTRUCTIONS	14
8.2	HOW TO CREATE SUCTION PIPES	17
8.2.1	Suction pipe path.....	17
8.2.2	Suction pipe for viscous liquids	19
8.3	Suction filter.....	20
8.3.1	Calibration pot	21
8.4	DISCHARGE PIPE	22
8.4.1	External safety valve.....	22
8.4.2	Pulsation dampener	23
8.4.3	Pressure gauge	27
8.5	EXAMPLE OF A SYSTEM FOR METERING PUMPS.....	27
8.6	Electric motor installation	28
8.6.1	R type pumps	28
8.6.2	Checking and changing the direction of rotation.....	29
8.7	Check project data	29
8.7.1	Environmental conditions.....	29

8.7.2	Installation conditions.....	29
8.8	START-UP	29
8.8.1	Checks before start-up.....	30
8.8.2	Checks during operation.....	30
8.8.3	Abnormal conditions	31
8.8.4	Prolonged stops.....	31
9	CHARACTERISTICS OF THE MACHINE	32
9.1	SPARE PARTS.....	32
9.1.1	INSTRUCTIONS FOR REQUESTING SPARE PARTS.....	32
9.1.2	Changes and manufacturing of spare parts without approval.....	32
9.1.3	SUGGESTED SPARE PARTS	32
9.2	Description of repairs and/or safety devices.....	33
9.3	Full range of applications for which the equipment has been created.....	33
9.4	PROHIBITED USES OF THE MACHINE	34
9.4.1	Environments in which use is prohibited	35
9.4.2	Instructions for use in potentially explosive areas.....	35
9.5	Instructions on noise and vibrations emitted by the machine.....	35
9.6	Instructions on vibrations, radiations, dust, gas, and vapours emitted by the machine	35
9.7	Documents attesting the conformity of equipment to regulations	35
9.7.1	Electromagnetic compatibility.....	35
9.7.2	Additional note for ATEX pumps	36
10	OPERATION.....	37
10.1	OPERATING PRINCIPLE.....	37
10.2	FLOW RATE	38
10.2.1	Flow rate adjustment system	39
10.3	Instructions for identifying and localising faults, for repair and restart after interventions	39
10.3.1	Flow lower than expected	40
10.3.2	Flow irregular or higher than expected.....	41
10.3.3	The plunger moves irregularly while pump is in operation.....	41
10.3.4	The pump body and/or motor are overheating	41
10.4	Instructions regarding personal protective equipment that must be used	42
11	MAINTENANCE.....	42
11.1	ROUTINE MAINTENANCE.....	42
11.1.1	OPERATING PRECAUTIONS.....	43
11.1.2	CONSULTING TECHNICAL DOCUMENTATION	43
11.1.3	PERIODIC OPERATIONS	44
11.2	DISMANTLING, REPLACEMENT AND REASSEMBLY.....	45
11.2.1	Disconnecting electrical connections.....	46
11.3	CHECKING AND REGISTERING THE PLUNGER SEAL	46
11.3.1	Head WITH plunger packing ring nut	46
11.3.2	Head WITHOUT plunger packing ring nut.....	48
11.4	VALVE CHECKS/REPLACEMENT.....	48
11.4.1	R type pumps with lip seal	48
11.4.2	R type pumps with METAL heads and pack seal	49
11.4.3	R type pumps with PLASTIC heads and pack seal	50
11.4.4	Pump type R-TS	52
11.4.5	Pump type RH with METAL heads.....	53
11.4.6	Pump type RH with PLASTIC heads.....	54
11.5	SPECIAL MAINTENANCE.....	58

11.5.1	TECHNICAL DOCUMENTATION	58
11.5.2	PUMP HEAD MAINTENANCE.....	58
11.5.3	Dismantling the pump head	59
11.5.4	Plunger seal checks and/or replacement	59
11.5.5	Plunger checks and/or replacement.....	60
11.5.6	Pump head tightening torque	63
11.6	REPLACING BEARINGS	64
11.6.1	Reassembly.....	64
11.7	EMERGENCY SITUATIONS	64
11.7.1	Type of fire-fighting equipment to used	64
11.7.2	Warnings on possible emissions/leakage of harmful substances	64
12	DECOMMISSIONING.....	64
12.1	DISCONNECTING THE PLANT	64
12.1.1	PROVISIONS FOR RETURNING GOODS TO OBL (PUMPS UNDER WARRANTY).....	65
12.1.2	SENDER RETURN REJECTED	66
12.1.3	PROVISIONS FOR RETURNING GOODS TO OBL SERVICE CENTRE (PUMPS NOT UNDER WARRANTY).....	66
12.2	STORAGE FOR LONG PERIODS.....	66
12.3	DISPOSAL AND DEMOLITION	66
13	SAFE PUMP USE	68
13.1	WARNINGS.....	68
13.1.1	SYMBOLS AND SUGGESTIONS IN THESE INSTRUCTIONS.....	68
13.1.2	HAZARD.....	68

1 CE MARKING

1.1 Plate position on the machine

Each pump carries a nameplate for identification. Below is a representation of an example and its position:

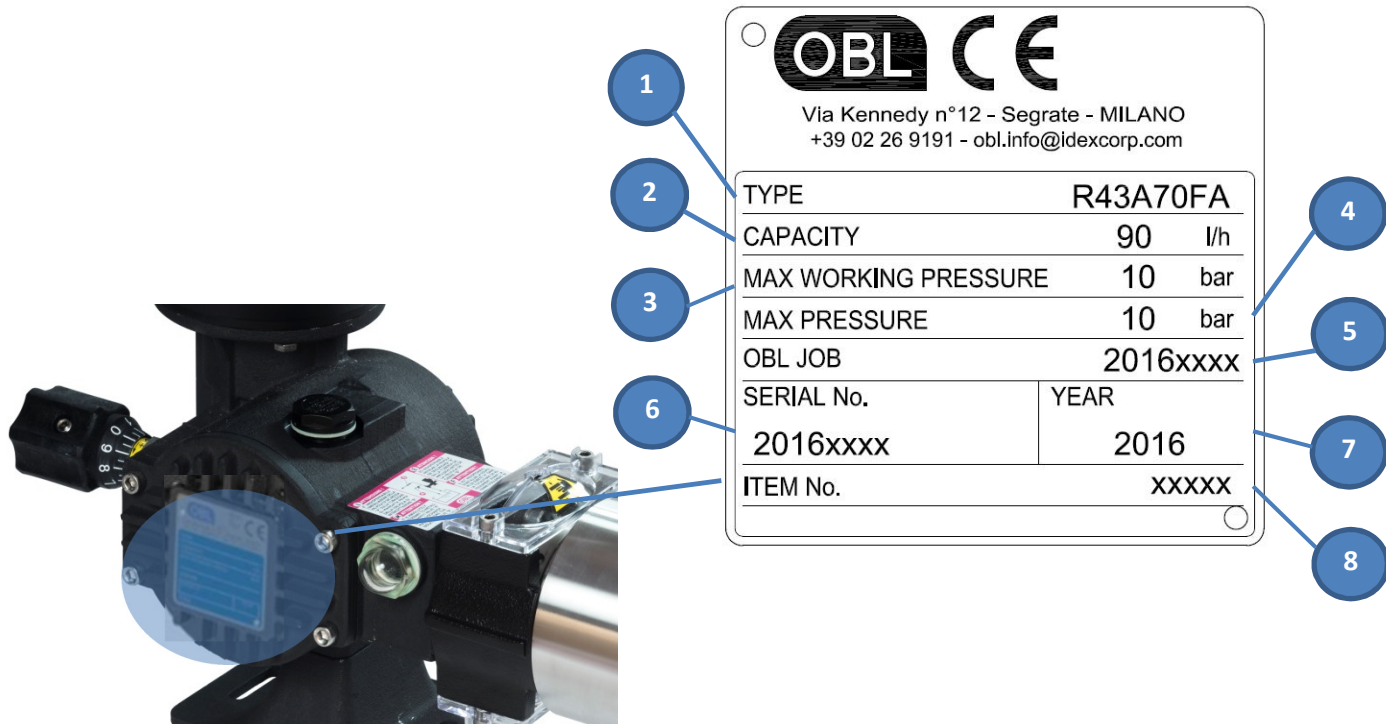

1 = Pump identifying code	2 = Maximum flow rate (l/h with adjustment at 100%)
3 = Maximum operating pressure (bar)	4 = Maximum allowed pressure (bar) (see Note 1)
5 = OBL Job Number (Order Confirmation)	6 = Pump serial number
7 = Year of manufacture	8 = Item (where applicable)

Note 1: NEVER exceed this pressure value, even when opening (exhaust) the external safety valve!

Ensure that the machinery data plate, warning and service stickers are always present, legible, and in good conditions. If not, replace them.

 **Removal of the data plate or alteration of data contained therein is NOT permitted for any reason.**

1.2 PUMP IDENTIFYING CODE

R series plunger metering pumps with spring mechanism are identified by initials composed as follows:

.../ R 16 A 70 SV TL FA G - M...

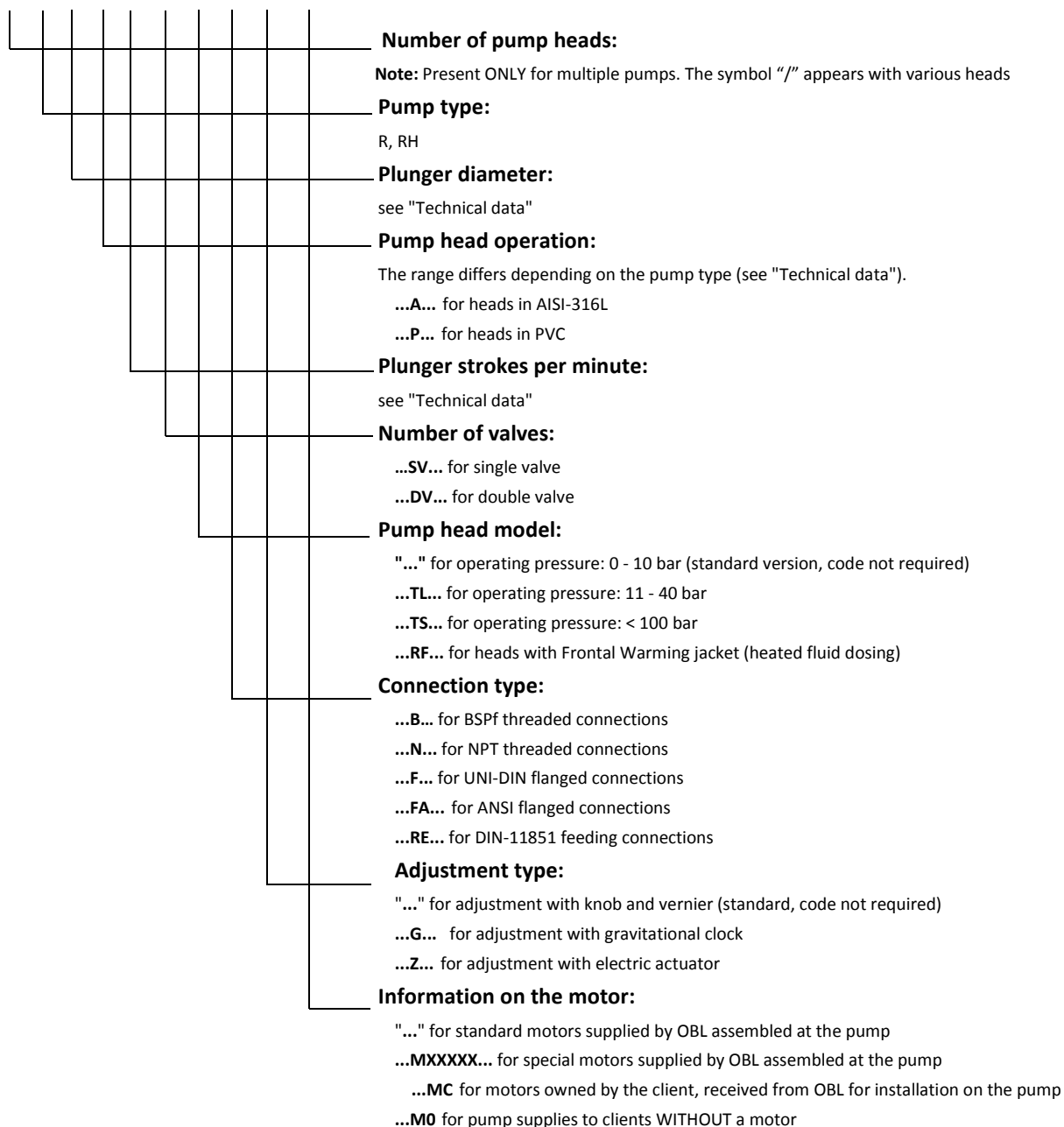

Manufacturing variations may differ from those described in special operation machines.

2 DECLARATION OF CONFORMITY



DECLARATION OF CONFORMITY

(in accordance with Machinery Directive 2006/42/EC and subsequent amendments, Annex II/A)

The Company



OBL s.r.l. - Via Kennedy, 12

20090 Segrate – MILANO – ITALY

Declares under sole responsibility that the machine

PLUNGER METERING PUMPS BLACKLINE 2.0 SPRING RETURN MECHANISM

MODELS

PUMP TYPE	R	RH	HR
------------------	----------	-----------	-----------

Description: Controlled volume alternative displacement pumps

Name and address of the authorized person to constitute the technical construction file:

C.V.Carbone Address: OBL S.r.l., Via Kennedy, 12 - 20090 Segrate (MI) – Italia

The machine complies with the relevant provisions of Directive 2006/42/EC and subsequent amendments and additions, implemented in Italy by Legislative Decree 17/2010 - Machinery Directive.

It furthermore complies with the following directives:

- EU Directive 2014/30/EU on electromagnetic compatibility
- EU Directive 2014/35/EU on low-voltage electrical equipment
- EN 12100:2010 Safety of machinery - General principles for design - Risk assessment and risk reduction.

PLACE AND DATE	ROLE AND NAME OF ISSUER	SIGNATURE OF THE ISSUER
17/01/2017 SEGRATE (MI) - ITALY	General Manager Daniele Di Cesare	

3 INTRODUCTION

The machines covered by the following "instructions" are intended for operation in industrial areas and therefore cannot be treated as products for retail (consumer).



This document therefore contains information to be used by qualified personnel only.

They must also be integrated by laws and technical regulations in force and do not replace any plant regulation provisions or any additional requirements, either legislative or non, which have been issued for safety purposes.

The purpose of these instructions is to refer information deemed necessary for understanding as much as possible about and facilitating the installation, commissioning, use and maintenance of **R series plunger metering pumps with a spring return mechanism**, hereafter called, for short, **R series pumps**.

Although the **R series pump** family includes **RH** pumps, each type with numerous variations (see "Identifying code" and "Technical data"), the technical information contained in this instructions manual **is equally appropriate and applicable** (except where expressly stated) **for any pump whose code start with the letter "R"**.

OBL reserves the right to modify the characteristics of its products at any time to apply the latest technological innovations. The information contained in this document is therefore subject to change without notice.

This document is property of OBL S.r.l. together with the technical information contained in it. Modification, reproduction or copying (in whole or in part) of it without written permission is prohibited. Violations will be prosecuted by law.

UNDERSTANDING EQUIPMENT



Attention! When using mains-powered equipment, always follow basic safety precautions, including the following, to reduce damage to people and property:

- Carefully read the instructions in this manual before using tools.
- Keep these instructions for future use.

4 REGULATORY FRAMEWORK

The information in Annex I of Legislative Decree. N. 17 of 27/01/2010, implemented in Directive 2006/42/EC, has been referred to for preparation of this manual.

A number of technical standards have been used as a reference to comply with current safety standards in the workplace in the design, construction and implementation of the machine.

5 PRESENTATION

R series plunger pumps are all with a spring return mechanism, coupled to a pump head in chemically material (plastic or metal) that is compatible with the fluid to be dosed. The mechanism body incorporates a transmission reduction gear, a plunger thrust system and a flow rate adjustment system.

The sectional drawing of the pump is usually attached to this operating manual. If it is not attached, see "Pump head dismantling" for the pump head section or else contact OBL customer support to receive an updated copy.

They are normally powered by an electric motor through a worm-type reduction gear with helical gear joined to a duct mechanism. The latter is composed of a fixed eccentric and a spring which determines the alternative axial movement of the plunger. Both mechanisms are in an oil bath.

5.1 INSPECTION AND GUARANTEE

5.1.1 Inspection

All OBL metering pumps are reliable, quality products which have been subject to careful end inspection to ensure proper operation and to ascertain compliance with specified performance. The results of these end inspections are registered in special forms and made available to the Client, if required by contract. A machine which has passed inspection is given a green label, applied to the finished product by the inspection supervisor.

5.1.2 Guarantee

Metering pumps, as with all other OBL products, are ensured for a period of twelve (12) months of operation but in any case no longer than eighteen (18) months from the delivery date on the DDT. The guarantee covers the replacement, free of charge and ex-factory in Segrate (MILANO) ITALY, of any component found to be defective in material or processing by the OBL technical office.

The guarantee IS NOT VALID in the following cases:

- components subject to normal wear (i.e. rings)

- whenever installation or use do not comply with the technical conditions of sale and instructions
- whenever the pump has been tampered with or dismantled
- whenever the pump has been sold to a third party



ATTENTION: Always avoid dismantling or attempted repair of products still under guarantee, as doing so will void the guarantee. Always contact OBL customer support for information.

In the case of a guarantee claim, the pump must be sent postage paid to the OBL Segrate (MILANO) ITALY factory, accompanied by a description of the alleged anomaly.

For safety reasons, BEFORE shipping, the sender MUST ALWAYS contact OBL customer support (Tel. +39-02-26919.1) and operate as indicated in point "Provisions for returning goods to OBL".

5.2 RECEIVING INSPECTION

All material relative to supply is delivered to the shipper in perfect condition after thorough final testing and packaging (where applicable). Inspect goods immediately upon receipt and check that:

- the goods received correspond to the order made
- packaging (where applicable) has not undergone damage due to transport or has not been tampered with

If the packaging is damaged or tampered with, immediately check (quantity, quality and form):

- actual conditions of goods
- presence of all accessories or spare parts



ATTENTION: Should anomalies or damage be found IMMEDIATELY ISSUE A COMPLAINT WITH THE COURIER and inform OBL as well. We suggest contacting OBL customer support before commissioning.

5.3 SUPPLY CONDITIONS

All R series pumps are supplied as follows:

- ready to be installed as specified in the job order
- pre-tested in accordance with internal specifications
- not coated, but treated to ensure high protection against corrosion (coated only if specifically requested)

complete with lubricating oil (unless specifically requested)

5.3.1 OVERALL AND SECTIONAL DRAWINGS

Given the importance of these documents (which can undergo further changes or updates), they are not considered part of this instructions manual. Unless otherwise agreed, they are therefore manually attached (latest edition).

5.4 PERSONNEL RESPONSIBLE FOR MACHINE OPERATION

Personnel must be professionally employed in the sector and suitably trained and must have read and understood the instructions in this manual.

The employer must instruct all staff on the risks of accidents and on devices and clothing to be used for individual safety, on the risks arising from noise emission and on general provisions laid down by European Directives and legislation in the country of machine installation.

5.4.1 "Operator" personnel

The term "Operator" is intended as personnel that carries out the following tasks on the machine:

- performs the functions needed for operation
- operates regulation and operation controls
- performs simple actions related to operation
- performs any cleaning and daily inspection operations
- reports machine defects or malfunctions



The operator must work on the machine while protective guards are mounted and safety devices on

5.4.2 "Mechanical Maintenance" personnel

Intended as personnel that operates on the machine in all operating conditions and at all protection levels.

Performs all types of repairs or mechanical adjustments but does not work on electrical installations.

5.4.3 "Electrical Maintenance" personnel

Intended as personnel that operates on the machine in all operating conditions and at all protection levels.

Performs all types of repairs or mechanical adjustments, even in the presence of voltage.

6 TECHNICAL DATA

6.1 GENERAL DATA

6.1.1 Noise

The table below shows the average noise level (lp acoustic pressure) emitted by R series pumps, used within the limits of use and installed in accordance with the instructions in this manual.

These average values were detected on the prototype at a distance of 1 metre from the surface of the machine, at a height of 1.6 meters from the service deck and weighted according to curve A.

METAL HEAD		PLASTIC HEAD	
Maximum pump flow rate (Qmax)	Acoustic pressure level	Maximum pump flow rate (Qmax)	Acoustic pressure level
Qmax < 200 l/h	< 65 dB(A)	Qmax < 300 l/h	< 65 dB(A)
200 l/h < Qmax < 400 l/h	< 68 dB(A)	300 l/h < Qmax < 600 l/h	< 68 dB(A)
400 l/h < Qmax < 600 l/h	< 70 dB(A)	600 l/h < Qmax < 1000 l/h	< 70 dB(A)
600 l/h < Qmax < 1000 l/h	< 73 dB(A)	Qmax > 1000 l/h	< 73 dB(A)

The employer must implement appropriate technical measures to minimise risks arising from daily noise exposure and as much as is necessary to ensure and safeguard the health of personnel in the working environment.

6.1.2 Vibrations

R series pumps do not fall within the category of direct human contact machines. Vibrations produced are not significant when installed in accordance with these instructions. They are therefore less than 2.5 m/s² of acceleration and are not such as to cause hazardous situations. If these situations should arise, stop the machine immediately and call the maintenance supervisor.

6.2 DIMENSIONAL DATA

Unless otherwise agreed, the packaging bears such information (dimensions are expressed in millimetres and weight in kg).

6.3 ELECTRIC MOTOR AND POWER

The **R series pump** family has standard motors installed.

The table below shows the main characteristics of the motors installed in each type of pump

R "UNEL-MEC" MOTOR			R "UNEL-MEC" ⁽¹⁾ MOTOR		
Sz.	Shape	Poles	Sz.	Shape	Poles
71	B14	4	80	B14	4

(1) Optional

Powering the electric motor with an inverter



The pumps must have been expressly ordered for powering via inverter. Otherwise, before their use, the user must contact OBL to define new limits of use (Hz, pressure and flow) that will be guaranteed only after new fitting of pump data plates.

For a correct use of the pump, the user must comply with the frequency range allowed by OBL, defined and including from 30Hz to 80Hz. Moreover, IT MUST NOT EXCEED the max operating pressure indicated on the machine data plate. This value is downgraded and takes into account the maximum operating regime at maximum allowable power frequency (80Hz).

It must also comply with any additional instructions provided the inverter manufacturer. Solutions for meeting system electromagnetic compatibility (EMC) requirements are the responsibility of the installer.

6.4 TECHNICAL DATA BY PUMP TYPE

PUMP CODE	SURGES/MINUTE	CAPACITY L/H	MAX PRESSURE (bar)			CONNECTIONS				CONNECTIONS		MOTOR
			A	A-TL	P	THREADED		FLANGED		THREADED		
VALVES						A/A-TL	P	A/A-TL	P	A	P	
R 6	50	0.8	/	40	10	1/4" BSP f	1/4" BSP f	DN 15 or 1/2" ANSI 150 RF	DN 15 or 1/2" ANSI 150 RF			0.25 kW
	70	1.2										
	95	1.8										
	115	2.2										
CM 5	CTX 5											
R 10	36	2	10	40	10	1/4" BSP f	1/4" BSP f	DN 15 or 1/2" ANSI 150 RF	DN 15 or 1/2" ANSI 150 RF			0.25 kW
	50	3										
	70	4										
	95	5.5										
115	7											
CM 5	CTX 5											
R 16	36	5	10	40	10	3/8" BSP f	3/8" BSP f	DN 15 or 1/2" ANSI 150 RF	DN 15 or 1/2" ANSI 150 RF			0.25 kW
	50	7										
	70	11										
	95	15										
115	18											
CM 7	VP 7											
R 25	36	15	10	40	10	3/8" BSP f	3/8" BSP f	DN 15 or 1/2" ANSI 150 RF	DN 15 or 1/2" ANSI 150 RF			0.25 kW
	50	20		40								
	70	30		40								
	95	38		35								
115	45	30										
CM 7	VP 7											
R 30	36	20	10	40	10	3/8" BSP f	3/8" BSP f	DN 15 or 1/2" ANSI 150 RF	DN 15 or 1/2" ANSI 150 RF			0.25 kW
	50	30		40								
	70	40		35								
	95	55		26								
115	65	22										
CM 7	VP 7											
R 43	36	40	10		10	3/8" BSP f	3/8" BSP f	DN 15 or 1/2" ANSI 150 RF	DN 15 or 1/2" ANSI 150 RF			0.25 kW
	50	55										
	70	90										
	95	115										
115	150											
CM 8	VP 8.5											
R 50	36	58	10	/	10	1/2" BSP f	1/2" BSP f	DN 15 or 1/2" ANSI 150 RF	DN 15 or 1/2" ANSI 150 RF			0.37 kW
	50	80	10		10							
	70	120	10		10							
	95	160	9		9							
115	200	8	8									
CM 11	VP 11											
R 62	36	90	10	/	10	3/4" BSP f	3/4" BSP f	DN 20 or 3/4" ANSI 150 RF	DN 20 or 3/4" ANSI 150 RF			0.37 kW
	50	125	10		10							
	70	175	8		8							
	95	250	6		6							
115	300	5	5									
VM 13.5	VP 11											

6.5 ENVIRONMENTAL AND DESIGN TEMPERATURE

Unless otherwise agreed upon with the client, the ambient design temperature "Ta" of the plant for all types of pumps is:

-10°C ≤ Ta ≤ +40°C: Standard temperature range for all pump types

The table below illustrates the maximum allowed temperature of pumped fluid based on pump head material.

	"STANDARD" head features			
	Heads in METAL		PLASTIC head	
	ACV	OTHER	PVC (P)	PVDF (S)
PUMPED FLUID Max. temperature	+40 °C	+90 °C	+40 °C	+40 °C



NOTE: Always check that temperatures respect limits during periodic inspections!

The values indicates in the previous table are applicable equally for the allowable environmental temperatures "Ta".

	"RF" head features	
	PUMPED FLUID Max. Temperature	WARMING FLUID Max. Temperature
Heads in METAL	≤+90 °C	+130 °C

7 TRANSPORT - STORAGE

7.1 TRANSPORT, LIFTING AND HANDLING



Unless otherwise agreed, the pumps are mounted and packaged in horizontal containers. Make sure that they can not accidentally tip over during transport or handling and that they are set on a stable surface.

Verify that the device used (transpallets, forklift, hoist, etc.) is appropriate for the size and weight of the package/machinery and that any lifting rings on the machine are screwed down. In environments with temperatures below -20°C, lifting rings must be used with caution because they could break in low temperatures, causing damage to persons or equipment.



The lifting rings on the pump are sized to withstand the weight of a single-head pump and therefore should not be used to lift multiple pumps. Sling the base with lifting ropes for those operations. Fasten the pump safely to the base before freeing it. Tipping hazard!

7.2 STORAGE CONDITIONS

If not used immediately, the pumps should be stored with suitable covers in a temperate, dry, clean, vibration-free and weatherproof environment. Protect from soil moisture by placing the unit on shelves or wooden pallets. If the temperature is below 0°C, ensure that it does not go lower than -20°C.

If not specifically highlighted on the package, do not stack packaging, to prevent damage to the machine and to avoid tipping over or falling that can create accidents. Ensure that access of unauthorised persons is not allowed in the storage location and that the floor or shelf can support the weight of the machinery or equipment stored.

Before being put pumps into operation, bring them to a temperate environment in order to stabilise the temperature. Take additional safety measures in the case of storage in extreme conditions, i.e. in sub-tropical or desert climates.



Report special storage conditions in advance in order to provide for adequate packaging.



Check the dimensions and overall gross weight of the package before handling or lifting it.

8 COMMISSIONING

8.1 PRELIMINARY INSTRUCTIONS

Because check valves work by gravity, the valve axis must be perfectly vertical for proper pump operation (also to prevent abnormal wear).

Provide also for installation of the following equipment:

- **a pressure gauge** near the pump. It must be installed before any accessory installed on the discharge pipe. Allows control of actual pump operating pressure (see "Discharge pipes - Pressure gauge")
- **an external safety valve** immediately after the discharge connection and, in any case, before the SHUT-OFF valve. Protects the pump and system from accidents caused by excessive pressure (see "Discharge pipes - External safety valve")

- a **magneto thermal device suitable for the motor**. Protects the motor from overloading and/or electrical short circuits

 **ATTENTION: R series plunger pumps are displacement pumps that always require a safety valve, installed externally on the discharge line (see "External safety valve") to protect against any excessive pressure. The operating pressure must NEVER exceed the maximum allowed pressure indicated on the data plate, even when opening (exhaust) the external safety valve.**

 **Protect the pump from system product leaks and/or corrosion. Avoid rolling pipes or installing accessories directly above it. Avoid installation in a closed, corrosive or stagnant location.**

 **For outdoor installations, provide for proper pump protection from direct weathering (rain, wind, dust, humidity). Consider the benefits of using a canopy and/or sliding panels. These devices significantly raise the level of efficiency and safety of the entire pump.**

Provide for adequate free space around the entire pump to allow for checks and/or dismantling. In particular, from the pump head side, in correspondence with the adjustment system and from the motor side (see figure 3).

If the pump must be installed outdoors, a protective canopy is recommended, particularly if the same is equipped with actuators or other sensitive equipment.

Moreover, for PLASTIC material heads, provide for:

- an appropriate guard from direct sunlight to avoid thermal deformation of the head
- controls and/or periodic adjustments of head fastening bolt tightening
- periodic temperature checks of the dosed liquid
- periodic verification of absence of product leaks from pump connections or system pipes

Blocking the pump and pipes

Do not install the pump directly on a concrete base. Use a steel base, ensuring that it is stable and level. Fasten the pump securely to the base using bolts with washers to ensure proper load distribution.

The pipes must be supported independently and their weight must not burden or create tension on the pump head.

Therefore, in addition to the base, the pump requires a support structure of its suction and discharge pipes.

Connection of the system pipes

To facilitate dismantling of the pump from the system, provide for adequate drainage near the pump head on the discharge pipe.

Provide for fitting nozzles to facilitate dismantling of flanged connections (see figure 4).

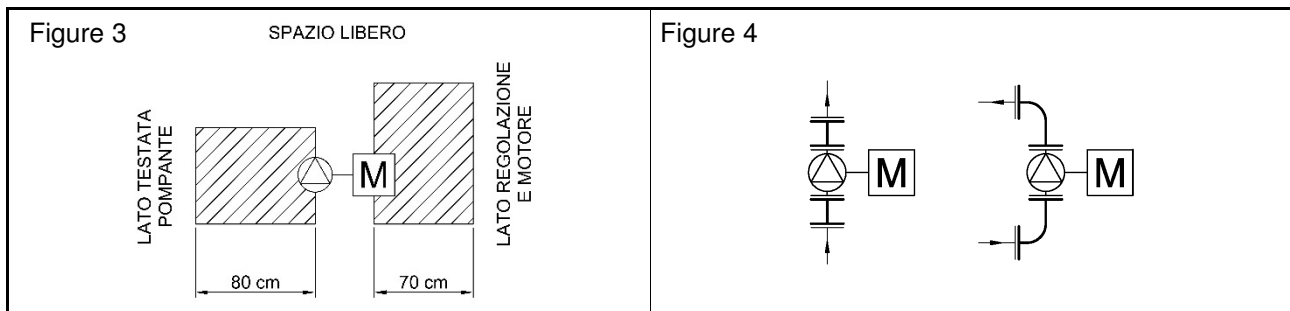

After discharge connection of the pump, we recommend the use of a cross connection, both to facilitate pump dismantling and to allow for (at a later time if necessary) installation of a pressure gauge, safety valve, pulsation dampener (dampener).

Always verify complete sealing of fittings and pipe flanges, particularly on the suction side.

The entry of suctioned air prevents pump priming.

⚠ Before connecting system pipes to pump connections, wash the pipes themselves. It is especially important to wash the suction pipe and its fuel tank. This operation is often underestimated by the installer with grave consequences as the pump becomes a collector of all impurities in the pipe and the tank: welding drops, seal cuttings, different types of soil and debris.

Connecting the motor to the mains

The metering pumps are supplied with use and maintenance instructions of the electric motor installed.

In addition, ATEX pumps are also supplied with safety instructions and ATEX certification and declaration of conformity.

⚡ Before carrying out electrical connections, ensure that power mains voltage corresponds to the information contained on the motor data plate. Consult motor instructions and comply with relative provisions.

When a cable entry is made via cable gland, the gland must be correctly chosen in relation to the type of system and type of cable used.

The cable gland should be tightened so that seal rings keep the necessary pressure:

- to prevent transmission of mechanical stress on the motor terminals
- to ensure mechanical protection (IP degree) of the terminal box

 **NOTE:** Always make the ground connection using the appropriate terminal in the terminal box.

8.2 HOW TO CREATE SUCTION PIPES

It is essential to set up the suction pipe properly to ensure proper pump operation.

Especially in the case of installations **above the head**, the factors to consider are:

- the internal diameter of the pipe
- the total length of the pipe
- the expansion or path of the pipe

The internal diameter of the suction pipe must be chosen based on pump flow rate (see following table A).

Pump connections are sized rounding up to cover all applications.

Table A

Suction pipe size based on maximum pump flow rate					
Maximum pump flow rate (Q _{max})	Quick couplings	Attachments		Flanged attachments	
		Threaded	Glued	UNI	ANSI
Q _{max} < 15 l/h	4 x 6 mm	-	-	-	-
15 l/h < Q _{max} < 30 l/h	6 x 10 mm	1/4"	-	-	-
30 l/h < Q _{max} < 125 l/h	-	3/8"	∅ 16 mm	DN 15	1/2" ANSI
125 l/h < Q _{max} < 155 l/h	-	1/2"	∅ 20 mm	DN 15	1/2" ANSI
155 l/h < Q _{max} < 260 l/h	-	3/4"	∅ 25 mm	DN 20	3/4" ANSI
260 l/h < Q _{max} < 500 l/h	-	1"	∅ 32 mm	DN 25	1" ANSI
Q _{max} > 500 l/h	-	1-1/2"	∅ 40 mm	DN 40	1-1/2" ANSI

8.2.1 Suction pipe path

The length of the suction pipe must be as short as possible, respecting the dimensions contained in the previous table A.

- for **above head** installation, do not exceed a maximum height of 1.5 metres
- do not exceed a maximum length of 2.5 metres (sum of the vertical and horizontal sides)

See indications illustrated in figure 5 for the suction pipe path.

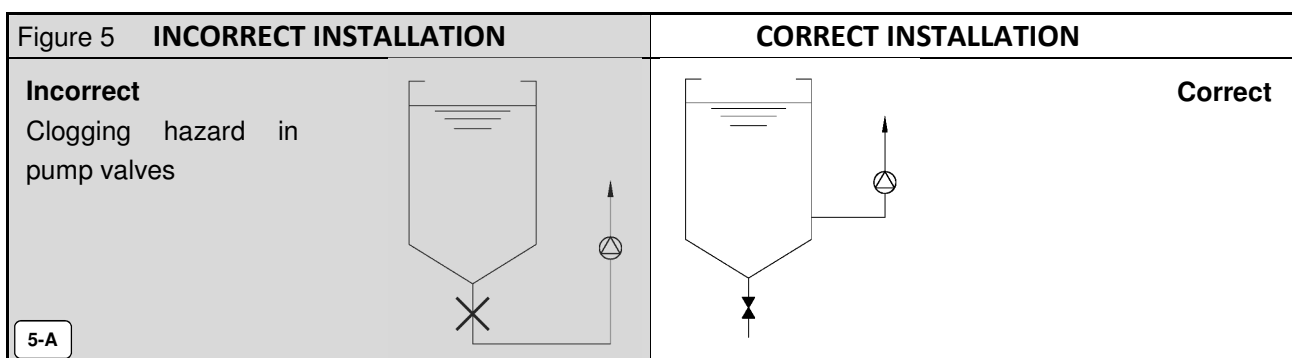
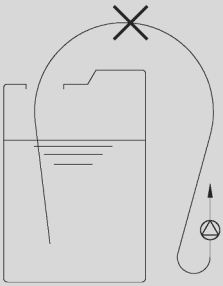
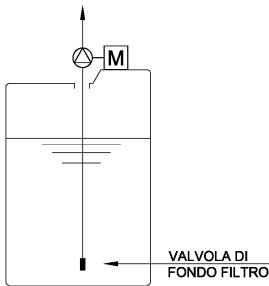
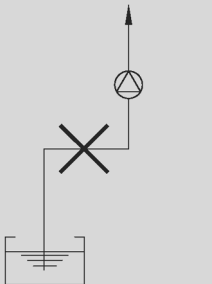
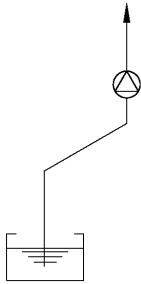
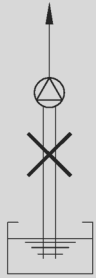
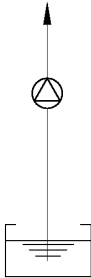
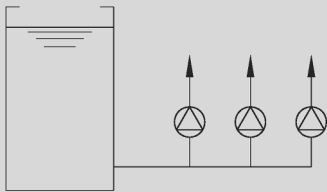
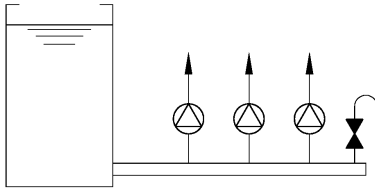
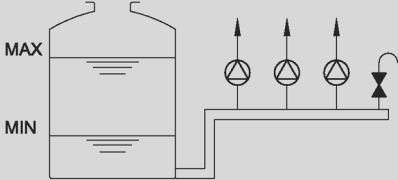
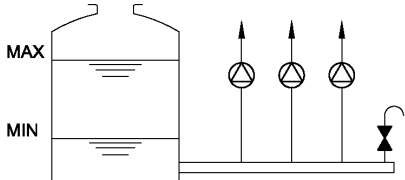
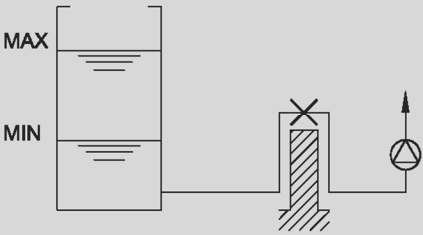
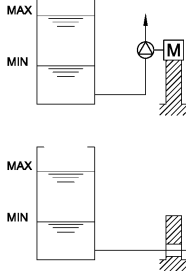
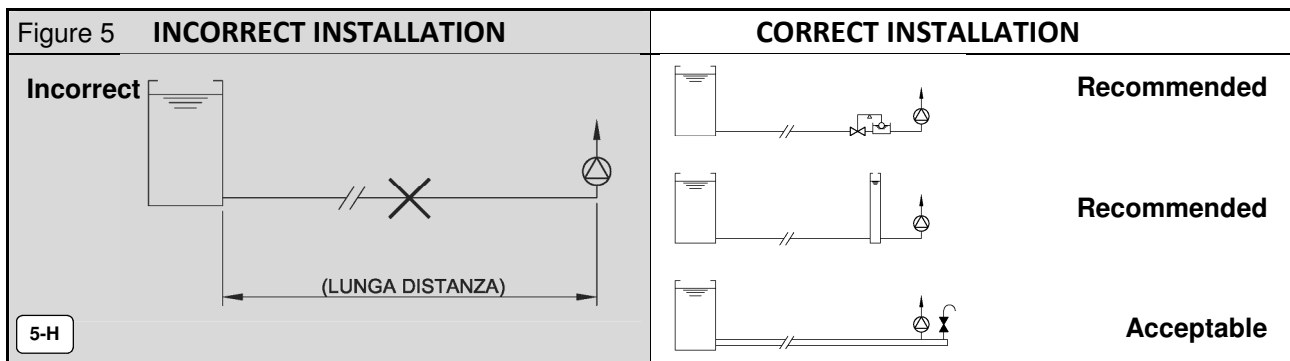

Figure 5 INCORRECT INSTALLATION	CORRECT INSTALLATION
<p>Incorrect The fluid vein breaks at the highest side of the pipe</p>  <p>5-B</p>	<p>Correct</p>  <p>VALVOLA DI FONDO FILTRO</p>
<p>Incorrect The fluid vein breaks and air remains trapped in the horizontal part of the pipe</p>  <p>5-C</p>	<p>Correct Suction pipe always upward</p> 
<p>Incorrect Internal diameter of suction pipe inadequate (see previous table A)</p>  <p>5-D</p>	<p>Correct Internal diameter of suction pipe proportioned (see previous table A)</p> 
<p>Incorrect</p>  <p>5-E</p>	<p>Correct</p> 
<p>Incorrect</p>  <p>5-F</p>	<p>Correct</p> 
<p>Incorrect</p>  <p>5-G</p>	<p>Recommended</p>  <p>Recommended</p>



8.2.2 Suction pipe for viscous liquids

Pumps for viscous liquid dosing must have been specifically ordered for that use.

Where possible, we recommend:

- use of plunger pumps with few strokes per minute and a large diameter plunger
- to use, in order of importance, a plunger pump, mechanical diaphragm or, lastly, a hydraulic diaphragm
- to use pump heads in stainless steel, or else with metal or special material valves
- avoid fitting a suction filter. If it is essential to evaluate its appropriate oversizing (see "Suction filter"),
- maintain the diameter corresponding to pump connections as the minimum diameter of the suction pipe



As a general rule, always install the pump under the head and pay special attention to the sizing and expansion of the suction pipe.



ATTENTION: A targeted selection of the pump means a definition of the available NPSH by the client !

Figure 6 illustrates some installation examples for viscous liquids.

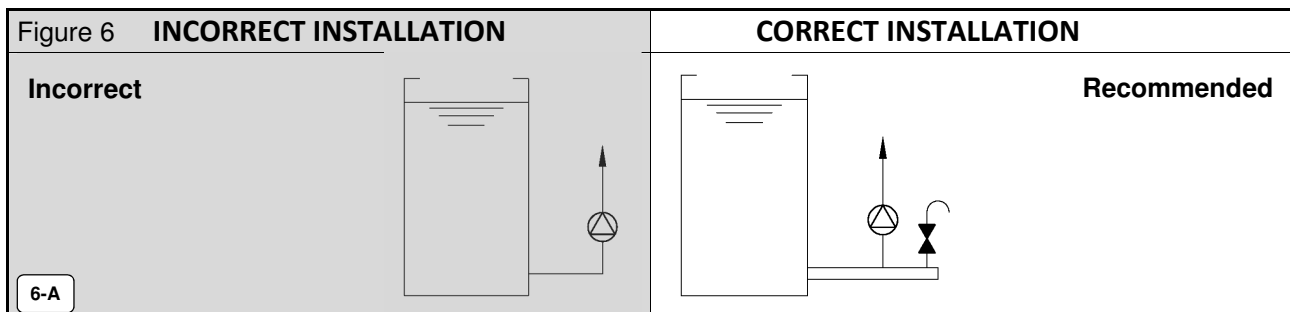

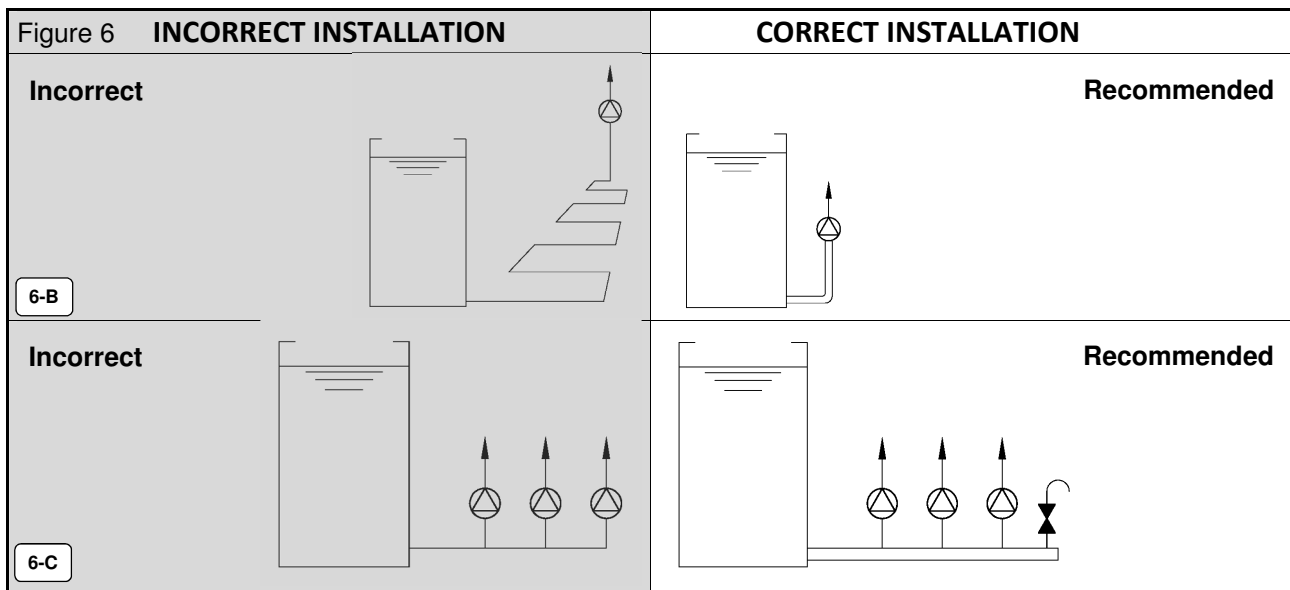

8.3 Suction filter

It is important that the product dosed is liquid, homogeneous and clean to ensure proper pump operation.

The use of the filter should not affect the suction capacity of pump. Carefully evaluate the real benefit of using the filter according to the nature and characteristics of the fluid. If it is best to use it, properly choose the size of its mesh filter.

The pump can also move suspended solids (insoluble) but these are always a source of disturbance as they can cause:

- check valve blockage
- accumulations and/or solidification in the head
- with diaphragm pumps, cutting or rupture of the same

As a general rule, **we do not recommend** filter installation in the following case:

- viscous liquid (i.e. polyelectrolytes)
- liquid that coagulates, solidifies or crystallises easily (i.e. caustic soda, ferric chloride)



ATTENTION: A small size filter may impede the suction flow, clogging up the pipe. Use Y filters with sizes larger than the diameter of the suction pump connection.

Mesh filter characteristics are linked to the nature of the liquid and the pump flow rate. See the table below for liquids with viscosities up to 200 cps.

Maximum pump flow rate (Q _{max})	Filter mesh (US standard)	Mesh opening (mm)
Q _{max} < 15 l/h	100	0.152
15 l/h < Q _{max} < 50 l/h	60	0.251
50 l/h < Q _{max} < 100 l/h	50	0.353
100 l/h < Q _{max} < 300 l/h	40	0.422
300 l/h < Q _{max} < 1000 l/h	30	0.599
Q _{max} > 1000 l/h	30	0.599

To avoid suctioning of impurities, especially in dosing liquids with suspensions, do not suction from the bottom of the tank but lift the suction point 10 cm from the bottom (see previous figure 5-A).

Figure 7 illustrates some installation examples of the suction filter.

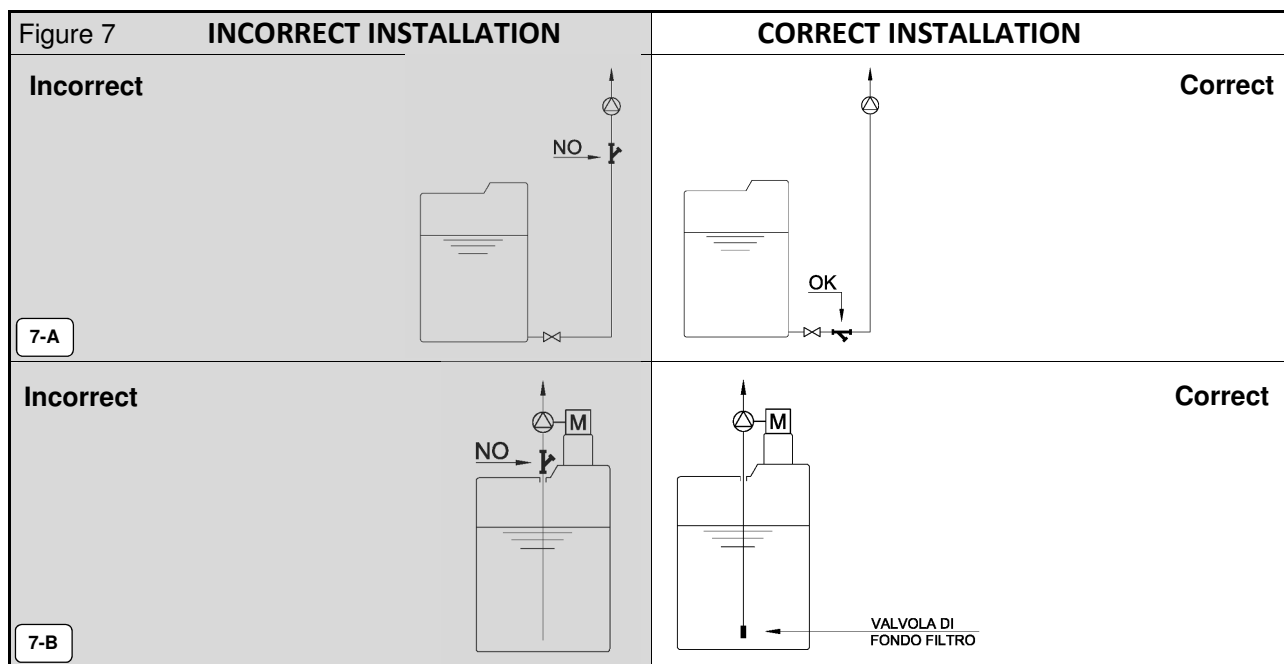

8.3.1 Calibration pot

Assesses valves conditions and verifies the actual operating flow rate of the pump under actual operating conditions and especially during normal operation of the plant, without interrupting the dosing process.

Is installed on the suction pipe between the tank and the metering pump (see figure 11).

It is not a required accessory but it can be very useful especially in the following cases: dosing of dangerous fluids, no pulsation dampener installed on the discharge, difficulty in verifying the actual flow rate of the pump operating on the discharge pipe.

8.4 DISCHARGE PIPE



Avoid setting up the discharge pipe or, worse, installing equipment directly above the pump.

If the water surface of the suction tank is higher than that of the target tank, siphoning may be triggered (see figure 8). The fluid transfers spontaneously and uncontrolled from the suction tank to the target tank, **going through the pump without it being able to control the flow rate in any way.**

To prevent this from happening, install a backpressure valve on the discharge pipe, or else raise the pipe and break the fluid lead. Discharge pressure must be higher than suction pressure by at least 0.3 bar (0.5 bar for small flow rates).

See indications illustrated in figure 8 for the discharge pipe path.

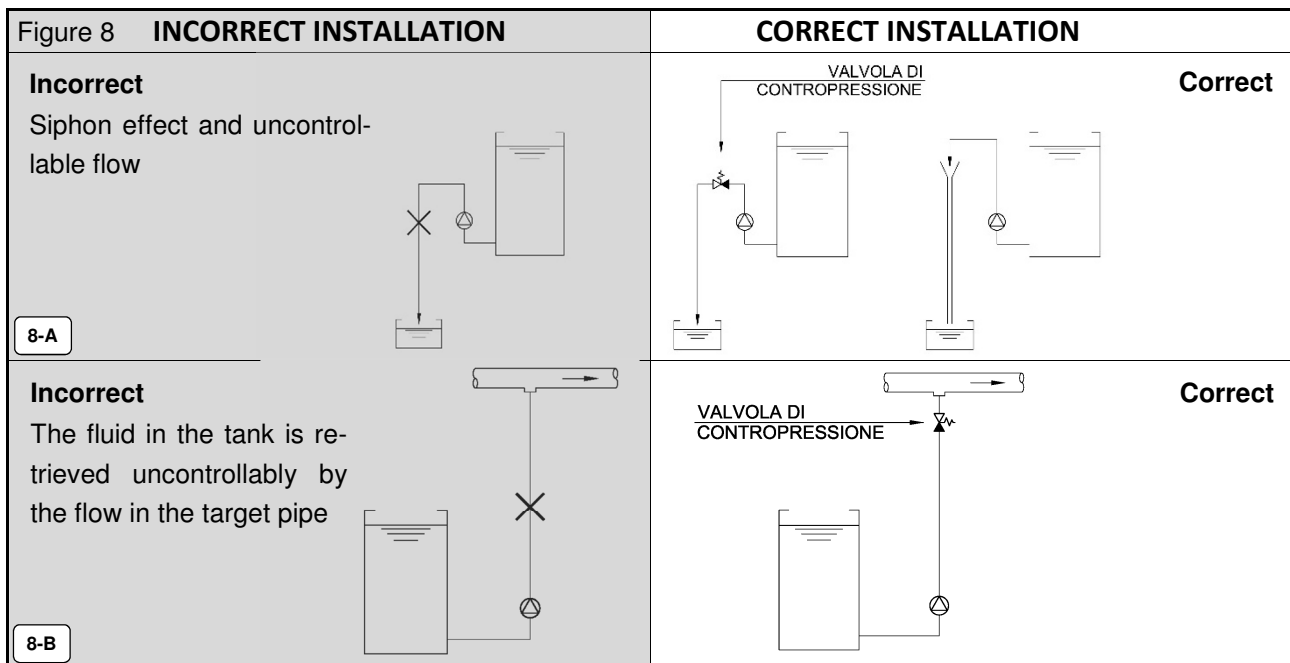

8.4.1 External safety valve

Plunger pumps are displacement pumps that always require a safety valve, installed externally on the discharge line near the pump and before any accessory equipment, to protect against any excessive pressure.



The EXTERNAL safety valve on the discharge pipe is essential when system pressure can rise quickly, unexpectedly and uncontrollably, regardless of pump operation.



ATTENTION: The operating pressure must NEVER exceed the maximum allowed pressure indicated on the data plate, even when opening (exhaust) the external safety valve. Possible damage to pump or equipment!

The external safety valve must be installed immediately after pump discharge connection and, in any case, before the SHUT-OFF valve (see figure 9). The exhaust must be visible, inspectable and aimed into a suction or drainage tank. Avoid connecting the discharge to the pump suction pipe (recirculation), **especially on small flow rate pumps**.

Consider use of an external safety valve in "free discharge" dosing as well.

Doing so prevents accident caused by the following risks:

- freezing or solidification of fluid in the pipe
- blockage or accidental crushing of flexible pipes
- variation of fluid viscosity as a function of temperature
- spraying of fluid through the nozzles
- other unforeseen risks which can cause quick, uncontrolled rises in pressure

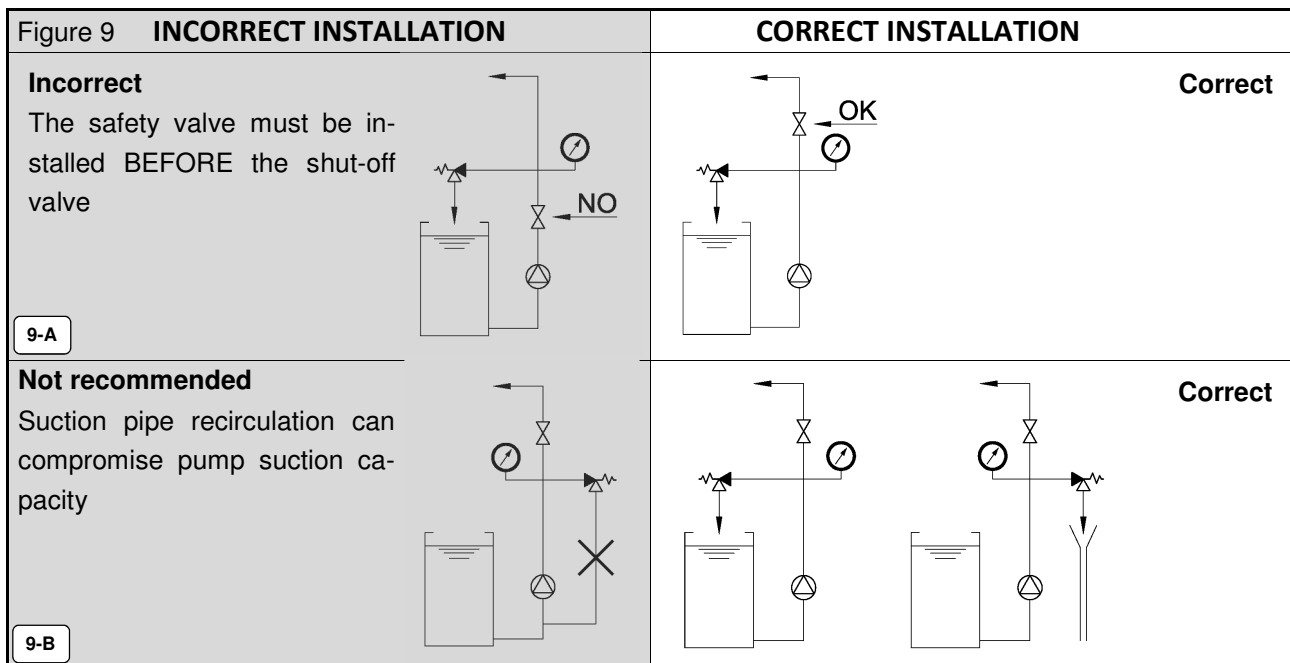

8.4.2 Pulsation dampener

The dampener is particularly important for improving the dosing process and pump operation.

There are various benefits obtained with its installation:

- protection of pump from peaks in pressure (pressure surges), increasing life expectancy
- flow rate becomes continuous with a linear flow, increasing reliability in the dosing process
- slight reduction of vibrations transmitted on the discharge pipe
- help in reducing noise of the pump



NOTE: If a continuous flow is essential to the process, install a pulsation dampener.

Due to its nature, the pump generates pressure peaks in the discharge pipe. In "closed circuit" dosing (example: in static mixers, press filters, other pressurised pipes), even if the process does not require constant flow/pressure, we suggest installing a pulsation dampener to absorb/reduce these peaks, to ensure correct dosing.

These peaks can in fact cause the opening (discharge) of the external safety valve located on the discharge pipe or that inside the pump (in the case of hydraulic diaphragm pumps), causing a marked decrease in flow and therefore problems with the process.

There are two types of pulsation dampeners on the market:

BOTTLE DAMPENER:

Fluids enters in the dampener and directly compresses the air inside it (without any means of separation).

Dampener volume is approximately 35 times the pump displacement.

Advantages: Less expensive compared to the bladder damper. Does not require pre-loading as it self-manages.

Disadvantages: Bulkier compared to the bladder dampener. "Vertical" installation is required. Requires periodic maintenance. It must be regenerated periodically, discharging fluid and restoring the air inside.

BLADDER PULSATION DAMPENER (pre-loaded):



Fluids enters in the dampener and compresses a pre-loaded separation bag or diaphragm (distension chamber).

Dampener volume is approximately 8 times the pump displacement.

Advantages: More compact compared to the bottle dampener. Can be installed vertically or horizontally. Does not require periodic maintenance or need to be regenerated as the preloading gas always remains closed in the bladder.

Disadvantages: More expensive compared to the bottle dampener. It is necessary to know the actual operating pressure of the pump beforehand to determine proper pre-load pressure. The operating pressure must always be higher than the preload pressure.

Figure 10 illustrates some installation examples of a pulsation dampener.

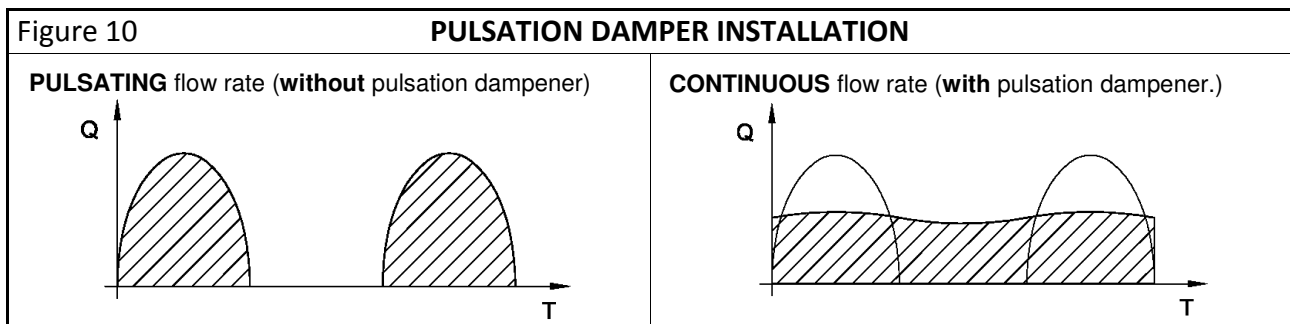

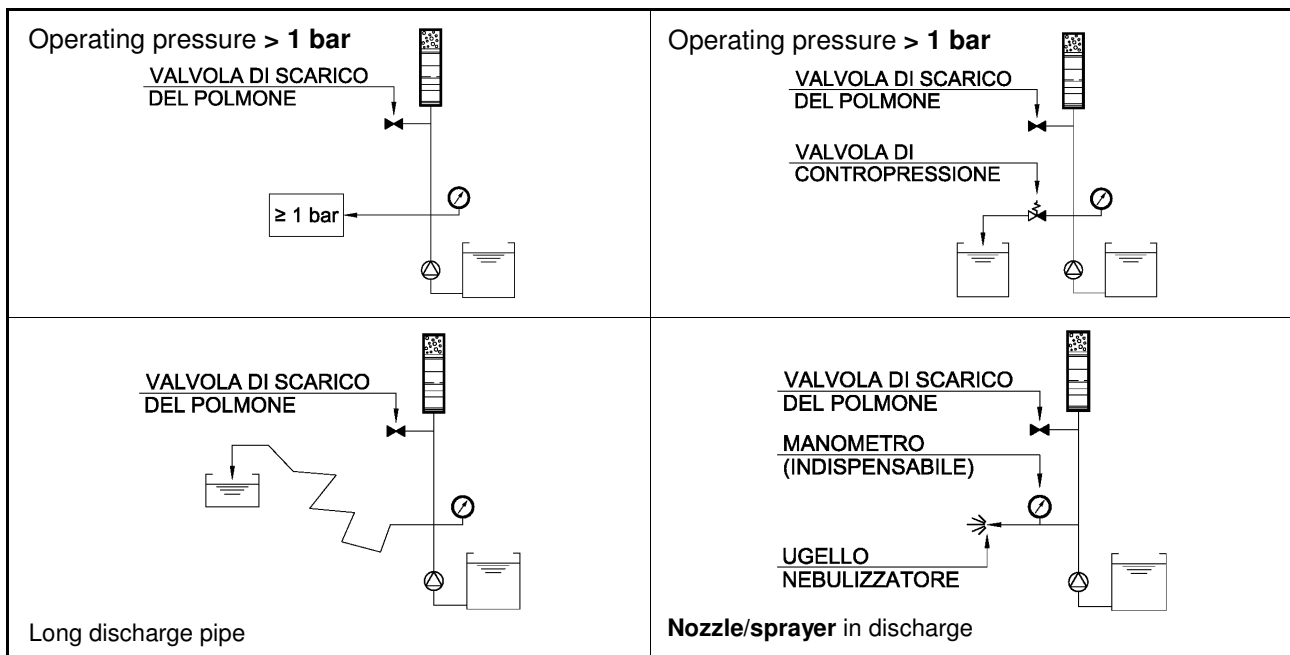

8.4.3 Pressure gauge

Always install a pressure gauge on the discharge pipe; near the pump, upstream from friction losses and before any other accessory (see previous figure 10). Know and control actual pump operating pressure.



ATTENTION: Knowing the actual operating conditions of the pump can prevent equipment damage and, especially, can prevent serious risk to persons or property in the system!

Consider use of a pressure gauge in "free discharge" dosing as well.

Doing so prevents accident caused by the following risks:

- freezing or solidification of fluid in the pipe
- blockage or accidental crushing of flexible pipes
- variation of fluid viscosity as a function of temperature
- spraying of fluid through the nozzles
- other unforeseen risks which can cause quick, uncontrolled rises in pressure



ATTENTION: The operating pressure must never exceed the maximum operating pressure indicated on the data plate, even when opening (exhaust) the external safety valve. Possible damage to pump or equipment!

8.5 EXAMPLE OF A SYSTEM FOR METERING PUMPS

All instructions for proper installation of metering pumps are grouped in figure 11.

Figure 11	EXAMPLE OF A SYSTEM FOR METERING PUMPS
-----------	---

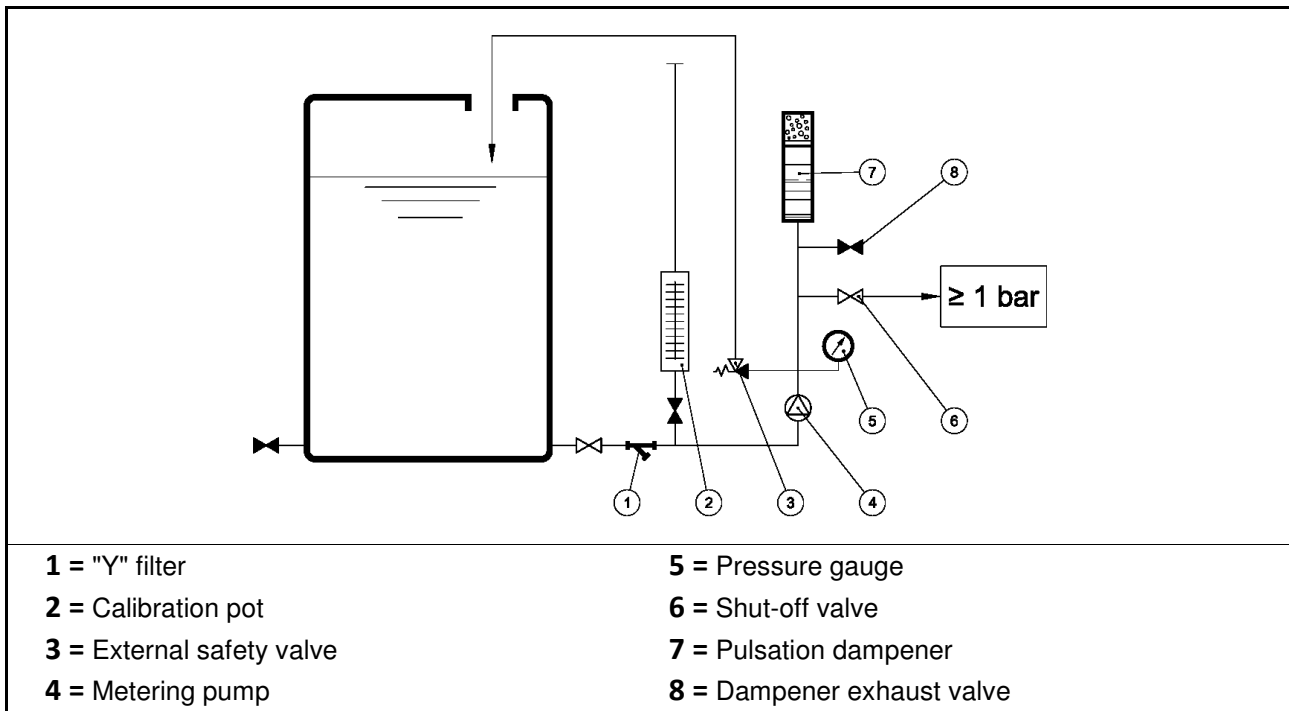

8.6 Electric motor installation

Unless otherwise agreed, the pumps are always supplied complete with an electric motor.

Technical requirements to be met are defined during negotiations for those pumps ordered explicitly without a motor (code ending in "M0").

⚠️ NON ATEX pumps supplied without a motor (codes ending in "M0"), it is the responsibility of the user to install a motor with power, rotational speed and coupling type that meet the technical requirements.

⚠️ ATEX pumps supplied without a motor (codes ending in "M0"), in addition to the above, it is the responsibility of the user to verify and install a suitable motor for the area classification and characteristics of flammable substances present in the system.

⚠️ ⚠️ OBL DISCLAIMS ALL RESPONSIBILITY FOR DAMAGES TO PERSONS OR PROPERTY CAUSED BY IMPROPER INSTALLATION OF MOTORS.

8.6.1 R type pumps

The motor (UNEL-MEC compliant) is coupled on the shaft on which the worm reduction gear of the pump is installed. Clean the end of the shaft, lubricate it with oil and then proceed with aligning it without banging and with caution on the input shaft. **Imprecise alignment can cause vibrations with damage to bearings or breakage to the shaft end.**

8.6.2 Checking and changing the direction of rotation

At first start-up of the pump, the direction of rotation of the motor should be checked by authorised, experienced and qualified personnel. An arrow on the motor indicates the correct direction of rotation (**counter-clockwise fan side**).



To reverse the direction of rotation of the motor, invert the two motor power phase cables. Recheck the direction of rotation after this activity.

8.7 Check project data

Make sure that the pump is suitable for operation in the actual operating conditions by checking the following:

8.7.1 Environmental conditions

- a) environmental temperature: verify that the actual room temperature is consistent with pump characteristics
- b) altitude: pump suction capacity can be influenced by atmospheric pressure. Verify the actual NPSH (A) characteristics in the system in relation to the NPSH(R) value of the pump.

8.7.2 Installation conditions

- a) pump installation and operation should only be carried out under the conditions described in the order.
- b) for ATEX pumps: pump classification (group and category) and the temperature class must be suitable for the installation area classification.



Operating conditions differing from normal conditions must always be defined when placing an order, to prevent that the pump work in conditions which may affect the proper functioning and safe operation.

8.8 START-UP

Pumps are ALWAYS supplied COMPLETE with lubricating oil (unless explicitly requested)

A temporary oil filler cap (without vent) is assembled together with a working cap (with vent) with a band to prevent oil leaks during transport (see figure 12).



ATTENTION: Replace the temporary cap with the working cap before start-up!

Perform first start-up with adjustment at at 20% and the lowest discharge pressure possible. Maintain this condition for at least 5 minutes. Gradually increase adjustment up to 100%, then position it in the conditions requested by the process.

During this first phase, check the actual operating pressure of the pump with a pressure gauge (see "Discharge pipe: Pressure gauge"). This value (max fluctuation of the pointer) must not exceed maximum pressure indicated on the pump data plate.



8.8.1 Checks before start-up

Check the following before starting up the pump:

- a) the presence of lubricating oil, by means of the oil level indicator, see "Checking lubricating oil"
- b) that there are no product leaks from pump connections or system pipes, especially on the discharge side
- c) direction of rotation of the motor and that the motor is protected as provided for by regulations, see "Electric motor installation"
- d) in the case of power via inverter, that it has been purchased for said use and complies with the range of frequency from 30Hz to 80Hz allowed and defined by OBL
- e) installation of all accessories and their proper operation
- f) that SHUT-OFF valves on discharge and suction pipes are open or closed depending on their function
- g) the liquid to be dosed has not solidified or frozen in pipes
- h) that it is protected from agents such as: sand, corrosive substances, dust and/or fibre, water, mechanical stress and vibrations
- i) that it is protected mechanically: indoor installation or outdoor installation considering the damaging effects of weathering, the combined influence of temperature, humidity and condensation

8.8.2 Checks during operation

Once the pump has been started, make sure that operating conditions remain without prescribed limits, by checking the following:

- a) pump operating pressure

- b) motor absorption current
- c) temperature of pumped fluid, if different from room temperature
- d) maximum surface temperature of the entire pump (max 40 °C on the pump reduction gear body and max 80 °C on the motor)

Check that pump suitability is maintained whenever changes in operating conditions occur, such as:

- modification of one or more process variables (i.e. operating pressure and/or pump flow adjustment)
- moving of the pump to a different environment (i.e. from indoors to outdoors)
- dosing of a fluid different from the initial fluid (change of pump use)
- moving of the pump from a low temperature environment to a higher temperature environment
- changes in season or major climate changes
- malfunction of any external safety valve installed on the discharge pipe

8.8.3 Abnormal conditions



The pump must be used exclusively for operating conditions determined in the order. In the case of abnormal operating conditions (high motor absorption, excessive surface temperature, high noise and/or vibrations) promptly notify the maintenance personnel.



OBL IS NOT LIABLE FOR DAMAGE CAUSED BY DEGENERATION BY MALFUNCTIONS NOT IMMEDIATELY RESOLVED OR REPORTED TO OBL.

8.8.4 Prolonged stops

If a prolonged period of pump stop is foreseen, take the following measures to preserve pump integrity: Cleaning of chemicals, protection from weathering, etc. (see also "General and surface cleaning").

9 CHARACTERISTICS OF THE MACHINE

9.1 SPARE PARTS

Standard components (screws, nuts, bearings, etc.) are also available directly from specialised dealers. **Replace all other components with original OBL spare parts.**

9.1.1 INSTRUCTIONS FOR REQUESTING SPARE PARTS

Procure and study the sectional drawing of the pump in use, requesting a copy from OBL if necessary. Analyse the conditions and identify the damaged components. Using the nomenclature of the sectional drawing, make a list of those components (cite the number of the sectional drawing and the position of the component) and send to the OBL Sales Office, always specifying:

- the type of metering pump (complete code)
- pump serial number
- OBL job number (in place of the serial number)



NOTE: This information is contained on the metering pump data plate.

9.1.2 Changes and manufacturing of spare parts without approval

OBL does not allow any changes. Original OBL spare parts and accessories are essential in maintaining compliance with safety regulations. The use of other parts will void the guarantee and any liability for consequences resulting from this action.

9.1.3 SUGGESTED SPARE PARTS

The most common faults can be solved by having the recommended spare parts in stock, thus avoiding unpleasant wastes of time.

Pumps with PLASTIC heads

This list is indicative; we suggest proceeding as detailed in "Instructions for requesting spare parts".

Position	Pump type	Component name	SV *	DV *
1	All	Plunger	1	1
2	R, RH	Plunger seal (seals pack)	1	1
4	R	Plunger seal (lip seals kit)	1	1
5	All	Valve seat	2	4
8	All	O-ring valve seat	2	4
9	All	O-ring valve container	2	2
15	All	Valve (ball)	2	4
55	All	O-ring	2	2

NOTE * Quantity recommended for: SV= Single Valve head, DV= Double Valve head

Pumps with METAL heads

This list is indicative; we suggest proceeding as detailed in "Instructions for requesting spare parts".

Position	Pump type	Component name	SV *	DV *
1	All	Plunger	1	1
2	R, RH	Plunger seal (seals pack)	1	1
4	R, R-ACV	Plunger seal (lip seals kit)	1	1
5	All	Valve seat	2	4
7	R, RH	O-ring valves	6	0
8	All	O-ring valve seat	2	4
9	All	O-ring valve container	2	2
15	All	Valve (ball)	2	4
77	R-TS	O-ring valve guide	0	4

NOTE * Quantity recommended for: SV= Single Valve head, DV= Double Valve head

9.2 Description of repairs and/or safety devices

See Chapter 13.

9.3 Full range of applications for which the equipment has been created

R series pumps are destined for dosing non-flammable liquid fluids (acids, alkaline, solvents, etc.) at room temperature or warmed (see "Environmental and design temperature"), suitable for discontinuous service (12/24 hours of operation).

They can be used for the following applications:

- pharmaceutical, food and agribusiness industries
- treatment plants/sewage treatment
- in paper mills, paper production lines
- in the production of detergents, CIP plants, water treatment plants



Any other use is considered "IMPROPER USE" and is not allowed. OBL declines all responsibility for any damage to persons or property and any kind of machine guarantee shall be considered void.

All pumps are supplied in compliance with requirements established under technical/sales negotiation and defined in the order.



NOTE: It is the responsibility of the client (user and/or installer) to check that the machine is suitable for application/use on the system before installation and subsequent start-up.



For ATEX pumps, it is the responsibility of the client/user to determine the effectiveness of the pump to be used in a system, after having analysed the characteristics of danger existing in the installation location and in compliance with current laws and those issued for safety purposes.

9.4 PROHIBITED USES OF THE MACHINE

It is improper to use the R series pumps as follows:

- without an external safety valve immediately after a discharge connection and therefore before any accessory
- for dosing products differing from those established during technical/sales negotiation and defined in the order
- in a corrosive and stagnant environment, closed in a poorly-ventilated location
- pressure dosing without a pressure gauge installed on the discharge pipe (see "Discharge pipe - Pressure gauge")
- powered by means of an inverter or other electronic drives unless explicitly ordered for this
- with a motor faster than the original one (different polarity)
- in potentially explosive areas unless explicitly ordered for this



NOTE: It is the responsibility of the client to check that the pump is suitable for application/use before installation and start-up. If in doubt, do not improvise but contact OBL customer support.

OBL is not able to monitor compliance with and enforcement of the provisions contained herein or the actual conditions and methods of installation, operation, use and maintenance of machinery and accessories.

Installation which has been performed incorrectly or misuse may cause serious damage and may pose a danger to persons or property.

Any anomalies must be reported to the maintenance supervisor. The user is not authorised to tamper with the machine for any reason.



Attempts to disassemble, modify or tamper in general by unauthorised personnel will void the guarantee and will release OBL from any liability for damage to persons or property resulting from such actions.

OBL is considered released from any liability in the following cases:

- improper installation
- improper use of the machine by non-professional or inadequately trained operators
- use not in compliance with regulations in the Country of use
- lack of maintenance or improperly performed maintenance
- use of non-original spare parts or parts which are not correct for the model in question
- total or partial failure to observe instructions

- exceptional environmental events

9.4.1 Environments in which use is prohibited

Use of the R series pumps in the following manners is prohibited:

- in mining plants (underground)
- under water (as submersible pumps)



Use of pumps without the protective covers or with safety devices altered or damaged IS STRICTLY PROHIBITED.

9.4.2 Instructions for use in potentially explosive areas



STANDARD operating R series pumps are not suitable for use in potentially explosive areas:



ATTENTION: R pumps in ATEX operation are not suitable for use in zone 0/20!

All **ATEX operating pumps** differ from **NON ATEX** (or standard operating) pumps in that they are fitted with a second identification plate with specific indication of the data required by the Directive.

9.5 Instructions on noise and vibrations emitted by the machine

See chapter 6.1.1 and chapter 6.1.2.

9.6 Instructions on vibrations, radiations, dust, gas, and vapours emitted by the machine

Work equipment during normal use/operation does not involve these risk factors.

9.7 Documents attesting the conformity of equipment to regulations

See chapter 2 for the declaration of conformity.

9.7.1 Electromagnetic compatibility

If installed properly and **with direct power supply from the mains**, R series pumps comply with emission limits set by regulations relating to electromagnetic compatibility (EMC - General requirements for industrial environments).



Pumps for power by means of inverters or other electronic drives need to have been especially ordered for said use. All checks and any necessary measures to comply with emission limits set by regulations shall be at the user's charge.

9.7.2 Additional note for ATEX pumps

Only R Series pumps in **ATEX version** comply with regulations concerning equipment and protective systems for use in potentially explosive atmospheres in accordance with the European Directive known as ATEX.

- They only meet the requirements of Group II Category 3, making them suitable for use in Zone 2/22 (No danger **during normal operation**)



ATTENTION: R pumps in ATEX operation are not suitable for use in zone 0/20, nor in zone 1/21!



NOTE: In the case of R pumps in ATEX operation, warnings contained in "Metering pump safety instructions for potentially explosive environments" (addendum to this operating manual) must be followed in addition to these instructions.

10 OPERATION

10.1 OPERATING PRINCIPLE

R series plunger pumps are all with a spring return mechanism, coupled to a pump head in chemically material (plastic or metal) that is compatible with the fluid to be dosed. The mechanism body incorporates a transmission reduction gear, a plunger thrust system and a flow rate adjustment system.

The sectional drawing of the pump is not attached to this operating manual (5.3.1). If it is not attached, see "Checks and/or replacement" for the pump head section or else contact OBL customer support to receive an updated copy.

They are normally powered by an electric motor through a worm-type reduction gear with helical gear joined to a duct mechanism. The latter is composed of a fixed eccentric and a spring which determines the alternative axial movement of the crosshead to which the plunger is attached. Both mechanisms are in an oil bath.

The motor type differs depending on the type of pump (see "Type of electric motor in relation to pump type").

In the discharge phase, the eccentric compresses the spring and, at the same time, forces the crosshead to move forward, causing piston movement and subsequently, the fluid in the head moves to the discharge pipe. In the suction phase, it is the extension of the spring to push the crosshead back, which pushes the piston again and provokes entrance of fluid in the head.

The check valve on the pump controls input and output of fluid from the head, determining flow direction.

The adjustment system of the flow controls the pumped fluid volume, varying plunger stroke. Standard adjustment is manual with knob and linear vernier.

Alternatively (upon request), an automatic adjustment system can be applied (see "Flow rate adjustment system").

R series pumps fall within the family of alternative displacement pumps characterised by adjustable displacement.

The plunger pumps always require an external safety valve on the discharge pipe (see "External safety valve") to protect it from any excessive pressure. The operating pressure must NEVER exceed the maximum operating pressure indicated on the data plate, even when opening (exhaust) the external safety valve.

The construction material of external components ensures high impact protection. With the exception of the head, external pump surfaces are treated to ensure high protection against corrosion. Metal parts are assembled to ensure their grounding.

Multiple pumps are obtained by assembling several pump bodies aligned horizontally, in which the eccentric shafts are fitted together with a flexible joint. The frequency of strokes per minute of the plunger independent and for this reason may be different for the different pumping heads tested.

10.2 FLOW RATE

R series pump flow rate is not continuous but pulsating, generated by the alternating movement of the plunger and the action of the check valve on the head which determine flow direction (see figure 1). Pump flow rate is adjustable and increases or decreases in direct proportion to the variation of the plunger stroke.

The theoretical flow rate corresponds exactly to the volume described by the movement of the plunger. The graphic representation of its behaviour is a straight line whose course is proportional to the adjustment system setting.

The actual flow rate is inevitably lower than the theoretical rate, due to the volumetric efficiency of the pump. It varies depending on the type and size of the pump, the nature and viscosity of the liquid to be pumped, operating pressure, etc. (see figure 2).

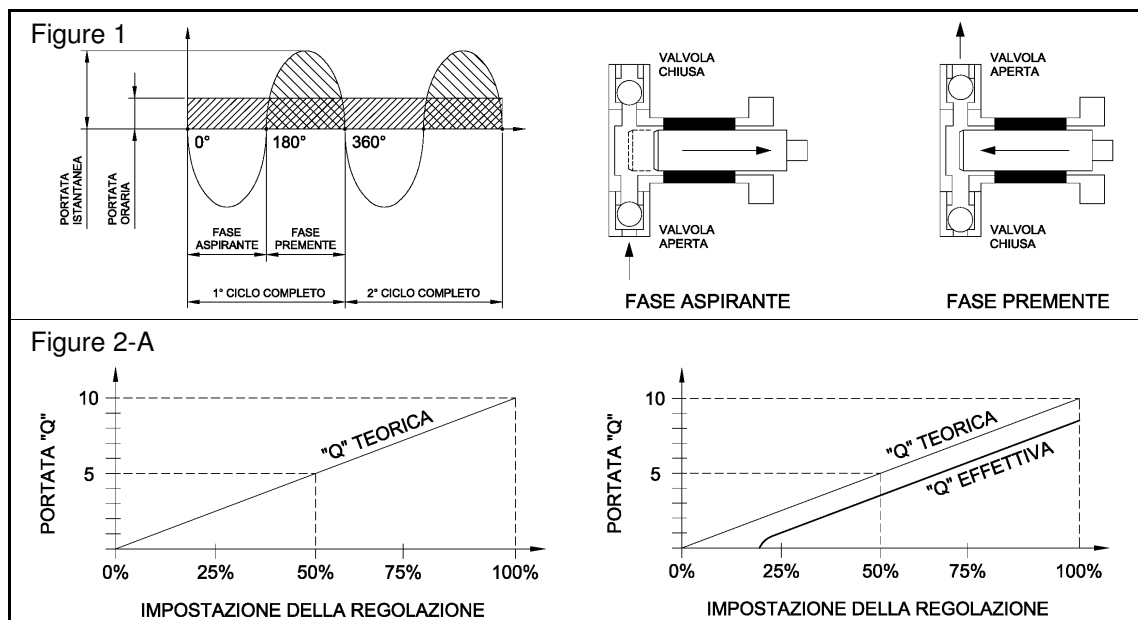

10.2.1 Flow rate adjustment system

Flow rate adjustment is continuous and regular and can be carried out both with the pump stopped and in movement. Activation with the pump running is, however, easier, especially for large diameter diaphragm pumps.

10.2.1.1 Manual adjustment with knob and linear vernier

The standard model is provided when no particular adjustment system is specifically requested.



The graduated knob, turning on a fixed vernier, runs on a linear scale subdivided from 0 to 10. Zero (0) on the lower edge of the knob is a reference index for setting the adjustment system to a desired flow rate percentage value.

10.2.1.2 Manual adjustment with a gravitational clock

An alternative manual model to the "basic" model (supplied upon request).

Easy and quick manual activation combined with precise, clear and immediate reading. The quadrant has a percentage scale (from 0 to 100) equipped with a pointer. Each full turn of the pointer corresponds to a variation in adjustment from 1% to 100%.



 ATTENTION: Adjustment with the gravitational indicator can be decalibrated during transporter handling due to sudden accelerations, shock or capsizing.

- Proceed as follows to reset decalibrated adjustment:
- start up the pump, remove the fastening set screw and extract the gravitational clock from the handwheel
- turn the handwheel counter-clockwise, stopping when the plunger remains STOPPED (despite the motor running)
- turn the clock hands, bringing the pointers to 0%, then reposition the handwheel

10.2.1.3 Automatic adjustment by means of electric actuator

The adjustment system can be automated (upon request) via the application of an electric actuator. For information on actuator operation, consult its operating manual.

10.3 Instructions for identifying and localising faults, for repair and restart after interventions

The tables below are not exhaustive. They only contain possible causes and suggested solutions relative to the most common and recurring faults.

10.3.1 Flow lower than expected

POSSIBLE CAUSE	SOLUTION
- Air is entering from the suction pipe junctions	- Check pipe and junction tightening
- Air trapped in the pump head	- Bring pump flow to an adjustment of 100% and maintain there for a short time
- Excessive suction height	- Reduce suction height
- Elevated vapour tension	- Increase suction head
- Elevated pumping temperature	- Increase suction head
- Elevated liquid viscosity	- Replace suction pipe with one of a larger diameter - Increase suction head
- Suction tank sealed and/or non-vented	- Make a hole on top of the tank
- Suction pipe clogged or closed by valves	- Check suction pipe
- Suction filter clogged	- Check filter cleaning
- Pump valves dirty, worn or assembled improperly	- Check the cleaning, wear and proper direction of assembly of pump valves
- Safety valve pressure set too low	- Check if the safety valve is intervening or not
- Wrong flow adjustment setting	- Check and correct settings if necessary

10.3.2 Flow irregular or higher than expected

POSSIBLE CAUSE	SOLUTION
- Suction pressure higher than discharge pressure	- Increase discharge pressure by at least 0.3-0.5 bar (3-5 m) with respect to the suction pressure
- Backpressure valve blocked at entry by impurities or set to too low a pressure	- Check backpressure valve conditions
- Pump valves blocked in an open position	- Check pump valves, dismantle and clean thoroughly

10.3.3 The plunger moves irregularly while pump is in operation

POSSIBLE CAUSE	SOLUTION
Excessive gland box tightening	Check and unscrew the plunger packing ring nut if necessary
Scalings on the seal and/or plunger surfaces	Check seal and plunger surface conditions

10.3.4 The pump body and/or motor are overheating

POSSIBLE CAUSE	SOLUTION
- Incorrect electrical connections	- Check electrical connections and motor absorption
- Actual pump operating pressure exceeding the maximum allowed	- Install a pressure gauge on the discharge pipe to verify and reduce actual pump operating pressure
- Discharge pipes undergoing section reductions which are drastically increasing operating pressure	- Reduce operating pressure or install a dampener to stabilise pressure (mitigate peaks)
- Pipes transit stress on pump connections	- Check and correct pipe connections on the pump
- Discharge pipe clogged or closed by valves	- Check discharge pipe
- Backpressure valve set to a pressure exceeding the maximum allowed	- Check backpressure valve



- Lubricating oil low or chemically contaminated

- Check and change lubricating oil if necessary

10.4 Instructions regarding personal protective equipment that must be used.

Any operation on the machine must be undertaken in compliance with safety regulations and safety warnings.

The safety supervisor must ensure compliance with applicable laws and safety regulations enacted for safety, and monitor that all personnel are equipped and always use appropriate personal protective equipment.

  **Appropriate personal safety devices must always be used to ensure and safeguard the personal safety of personnel, who must also be properly trained and professionally qualified.**

In general, the personal protective equipment to be used include:



- Mechanical/shear resistant gloves
- Protective clothing
- Safety shoes

All personal protective equipment (PPE) used by operators must have CE marking.

11 MAINTENANCE

11.1 ROUTINE MAINTENANCE

Each pump is a reliable, quality product, subjected to a thorough final inspection. In case of malfunction even though the pump has been installed and operated according to the instructions, do not act on your own but contact OBL customer service.

  **These maintenance suggestions are not intended as "do-it-yourself" repairs. To perform such works, specialised technical knowledge is required and operations are to be performed by qualified personnel.**

 **Interventions on electrical circuits or equipment must only be performed by qualified electricians or, under supervision, by appropriately trained personnel and in accordance with applicable electrical codes.**

 **In the case of ATEX pumps, be extremely careful that pump characteristics fitting the classification of the area where the system is installed are not altered.**



11.1.1 OPERATING PRECAUTIONS

All operations must be performed by qualified personnel.

Work on the pump must be authorised by the safety supervisor, after having determined that:

- a) the power line is disconnected and there is nothing being powered, including any auxiliaries
- b) any risk of accidental restart has been excluded
- c) pumped fluid present in the pump head and pipes is not under pressure or chemically hazardous
- d) **with the pump off**, that the shut-off valves on the suction and discharge pipe are closed
- e) the pump has been adequately cleaned, when operating in environments exposed to harsh chemicals

Since the machine to be supplied is a product designed for use in industrial areas, **additional safety measures must be adopted and ensured by the person responsible for the installation, if conditions require more restrictive protection.**

  **All works at the pump should be performed with the machine stopped and disconnected from the power mains (including auxiliary circuits). Maintaining original characteristics over time must be ensured by an efficient maintenance and inspection plan, developed and managed by qualified technicians, taking into account the service and the actual environmental conditions in which it operates.**

 **ATTENTION: During normal pump operation, the temperature of the motor housing can exceed 50°C. Wait and make sure it has completely cooled down before performing any operations.**

11.1.2 CONSULTING TECHNICAL DOCUMENTATION

Before starting work, consult this use and maintenance manual, identify the exact sectional drawing of the pump in use and obtain all the tools and equipment necessary for performing works.

NOTE: When the pump has been disassembled, waiting to be reassembled, it is necessary to protect the various components (particularly those inside the mechanism) paying special attention to working surfaces of ring seals) to prevent damage caused by oxidation or accidental impact.

 **Improper assembly of the sealing components or bearings can advance deterioration and result in malfunction and/or overheating.**

11.1.3 PERIODIC OPERATIONS

As a general rule, after first start-up, close initial monitoring is recommended to practically define the maintenance plan and determine the frequency of general inspections and planned maintenance.

If an abnormality occurs, it is the user's responsibility to consider whether to carry out maintenance earlier.

11.1.3.1 Normal operation checks

During periodic inspections, verify that:

- in the case of plunger pumps, there is no leakage of product pumped from the seal on the plunger
- there is no leakage of pumped fluid or lubricating oil
- the pump is operating properly, without abnormal noises or vibrations
- EC protections (accident prevention) are always mounted



Any defect or irregularity detected during inspections should be promptly removed!

11.1.3.2 Checks of electrical connections

Power cables, control and grounding cables must not have signs of deterioration and connections must be tight.

11.1.3.3 Connection of system pipe connections

Verify that connection units (flange ring nuts or screws and nuts) are firmly tightened and that relative sealing components are efficient and in perfect condition. During normal operation, pumps can transmit vibrations to pipes, loosening component connections and causing product leaks. If this is the case, install a pulsation dampener to reduce pressure peaks, making flow linear and reducing these vibrations.

11.1.3.4 General and surface cleaning

It is a good idea to periodically perform the following operations:

- a) if the pump has discontinuous service and pumped fluid tends to coagulate, solidify or crystallise easily, wash the pump head immediately after each stop
- b) prevent/eliminate surface deposits of material that can generate scaling
- c) remove any accidental presence of corrosive product from the outer surface of the pump



- d) ensure that motor ventilation is not impeded Remove any dust or fibres from the fins and the fan cover cap.

11.1.3.5 Protection against corrosion

Dosage of harsh chemicals or operating in exposed environments (acidic atmosphere) may expose the pump to corrosion and the risk of premature wear of sealing components. Periodically check:

- a) that protection covers are always mounted
- b) that operating windows are always properly closed
- c) that there is no oil contamination in the reduction gear that could endanger proper lubrication

11.1.3.6 Verification of thermal protection

  **Make sure that thermal motor protection has not been cut off and that it is calibrated correctly. Appropriate selection and calibration of thermal protections for ATEX pumps is essential in ensuring the temperature class and safety against explosion hazards.**

11.1.3.7 Painting checks (where applicable)

In the presence of corrosive agents, and whenever the need arises, periodically check for signs of paint deterioration such as to affect the equipment degree of protection.

Repaint whenever there is the need to protect exterior surfaces from corrosion.

11.1.3.8 Lubricating oil checks

R series pumps are supplied complete with lubricating oil in the reduction gear (unless specifically requested) and ready for operation.

Check **daily** that oil is at the halfway level of the cap and that there are no leaks from the dynamic seals or from the pump caps. Check that there is no oil contamination that could endanger proper lubrication. If so, change oil (see ""Replacing lubricating oil").

11.2 DISMANTLING, REPLACEMENT AND REASSEMBLY

The most common fault is caused by the directional valve of a dirty, clogged, worn or, worse, incorrectly mounted head.

 **ATTENTION: In the case of dosing faults, check actual conditions of directional valves BEFORE dismantling the pump head (see "Valve checks and/or replacement").**



Entrust maintenance, repairs and overhauls to experienced and qualified personnel who will restore original equipment conditions. Contact OBL customer support for information.

11.2.1 Disconnecting electrical connections

Disconnect all electrical connections before dismantling the pump. Make sure the machine cannot be accidentally restarted.

11.3 CHECKING AND REGISTERING THE PLUNGER SEAL

During periodic inspections, check for product leaks on the plunger seal.

The most common cause of leakage is related to the nature of the fluid, together with the actual working conditions of the pump.

During normal operation, the plunger and seal of plunger metering pumps are always directly in contact with the pumped fluid. If it tends to coagulate, solidify or crystallise easily, it is advisable to (periodically or immediately after each stop) wash the pump head to protect both the surface of the plunger and the integrity of the seal.



NOTE: ONLY metering pumps WITH plunger packing ring nut (pos.22) have an adjustable seal on the plunger.

11.3.1 Head WITH plunger packing ring nut

The operations are the same for any type of pump. We suggest, however, reference to the following figures during operation:

R type pumps: See figure 20

RH type pumps: See figure 21

The plunger seal (pos. 2) is adjustable. A seals pack composed of several "V" rings in Teflon-graphite (created as per OBL design) provides the water seal during pump operation.

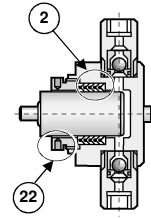

Operate with pump OFF. To eliminate product leakage:

- unscrew screws (pos.17) and remove protection covers (pos.97)
- unscrew the plunger packing ring nut (pos.22) turning one or two times, then clean and remove scaling
- apply grease to the thread (i.e. Vaseline) and with a pin punch (or an Allen screw), tighten the plunger packing ring nut (pos.22) to reset seal compression (pos.2)
- start up the pump and verify that product leakage have been eliminated. If leakage returns, "GRADUALLY" tighten the plunger packing ring nut (pos.22), avoiding a "plunger block"

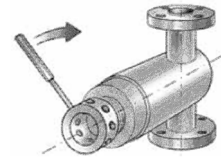

If however there is a continuing loss of product, it is reasonable to assume that the seal on the plunger is worn.

Then dismantle the head (see "Dismantling the pump head") and "physically" check the conditions of the seal on the plunger (see "Plunger seal checks and/or replacement") and of the plunger (see "Plunger checks and/or replacement").

11.3.2 Head *WITHOUT* plunger packing ring nut

The operations are the same for any type of pump. We suggest, however, reference to the following figures during operation:

R type pumps: See figure 19

The plunger seal (pos. 4) is NOT adjustable. A lip seals kit (usually a pair, created as per OBL design in material that is chemically compatible with the fluid being pumped) ensures the seal during pump operation.

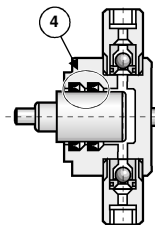

To eliminate leakage, replace the plunger seal (pos.4). See "Plunger seal checks and/or replacement."

Also check the plunger surface (pos.1) at this time. It should show no scratches, dents, corrosion or deposits which can cause damage to the new seal. Replace if necessary (see "Plunger checks and/or replacement").

11.4 VALVE CHECKS/REPLACEMENT

11.4.1 R type pumps with lip seal



NOTE: BEFORE dismantling, verify there is no pressure or high temperature in the pipes!

Operate with pump OFF. Proceed as follows to check conditions and/or replace valves (see figure 13):

- free the pump from the suction and discharge pipe and perform suitable cleaning
- remove the valve containers **one at a time** (pos.14)
- carefully remove the components without damaging them (use a plastic tool)
- carefully observe and check the direction of assembly of individual components
- check the cleaning, wear and proper direction of assembly of components
- the ball (pos.15) MUST be SMOOTH and not have dents or corrosion
- the valve seat (pos.5) must have a smooth, continuous seal that is free of dents
- the seal o-rings (pos.8,9 or 55) must be whole
- replace components where necessary
- reassemble everything exactly as shown in figure 13



ATTENTION: The ball (pos.15) MUST rest on its seat (pos.5) on the surface OPPOSITE to the smooth side.

Figure 13

R PUMPS (LIP SEAL): PUMP HEAD COMPONENTS

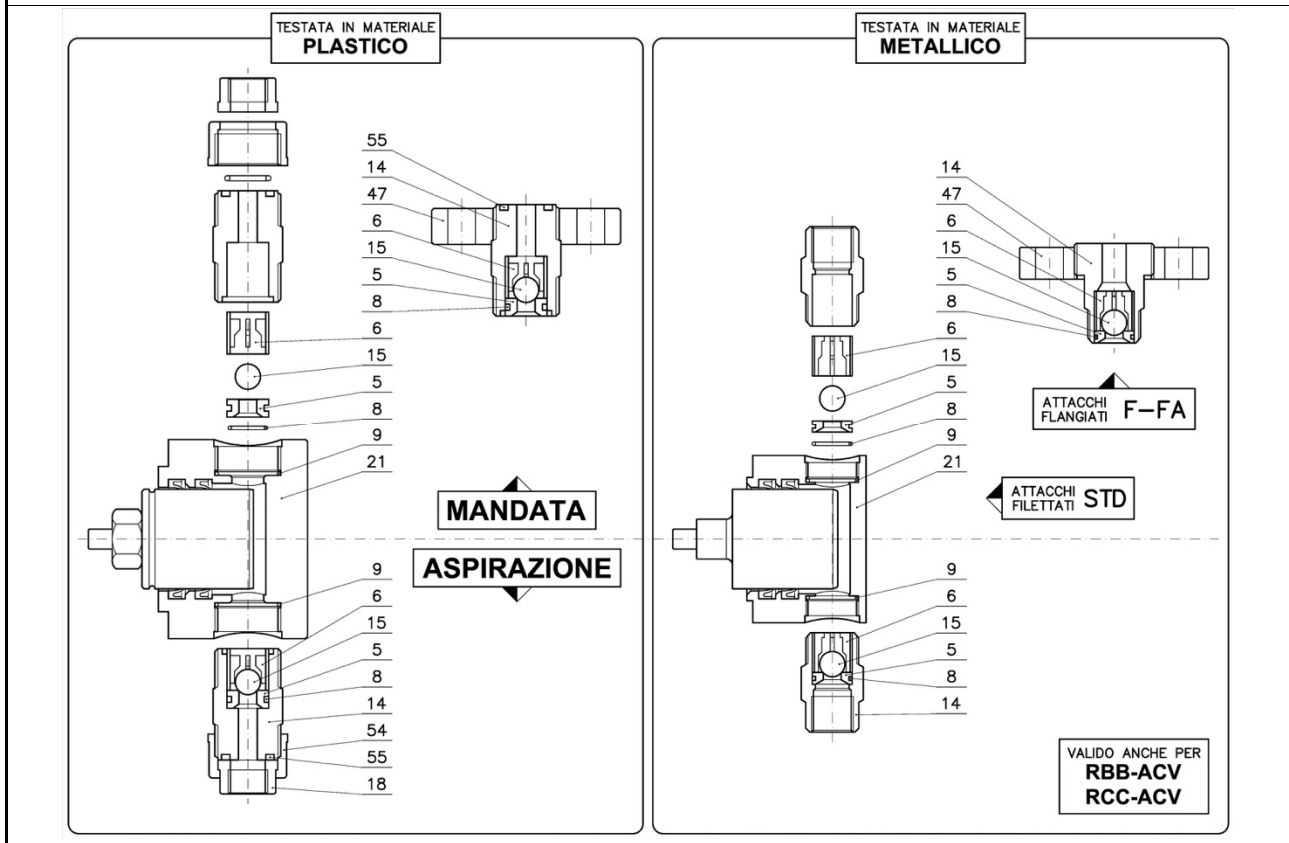

11.4.2 R type pumps with METAL heads and pack seal



NOTE: BEFORE dismantling, verify there is no pressure or high temperature in the pipes!

Operate with pump OFF. Proceed as follows to check conditions and/or replace valves (see figure 14):

- free the pump from the suction and discharge pipe and perform suitable cleaning
- plunger diameter 6-50 mm: remove the valve containers **one at a time** (pos.14)
- piston diameter 62 mm: dismantle **one valve unit at a time**, unscrewing the valve tensioners (pos.23)
- carefully remove the components without damaging them (use a plastic tool)
- carefully observe and check the direction of assembly of individual components
- check the cleaning, wear and proper direction of assembly of components
- the ball (pos.15) **MUST** be SMOOTH and not have dents or corrosion
- the valve seat (pos.5) must have a smooth, continuous seal that is free of dents
- the seal o-rings (pos.7,8 or 9) must be whole
- replace components where necessary

- reassemble everything exactly as shown in figure 14



ATTENTION: The ball (pos.15) MUST rest on its seat (pos.5) on the surface OPPOSITE to the smooth side.

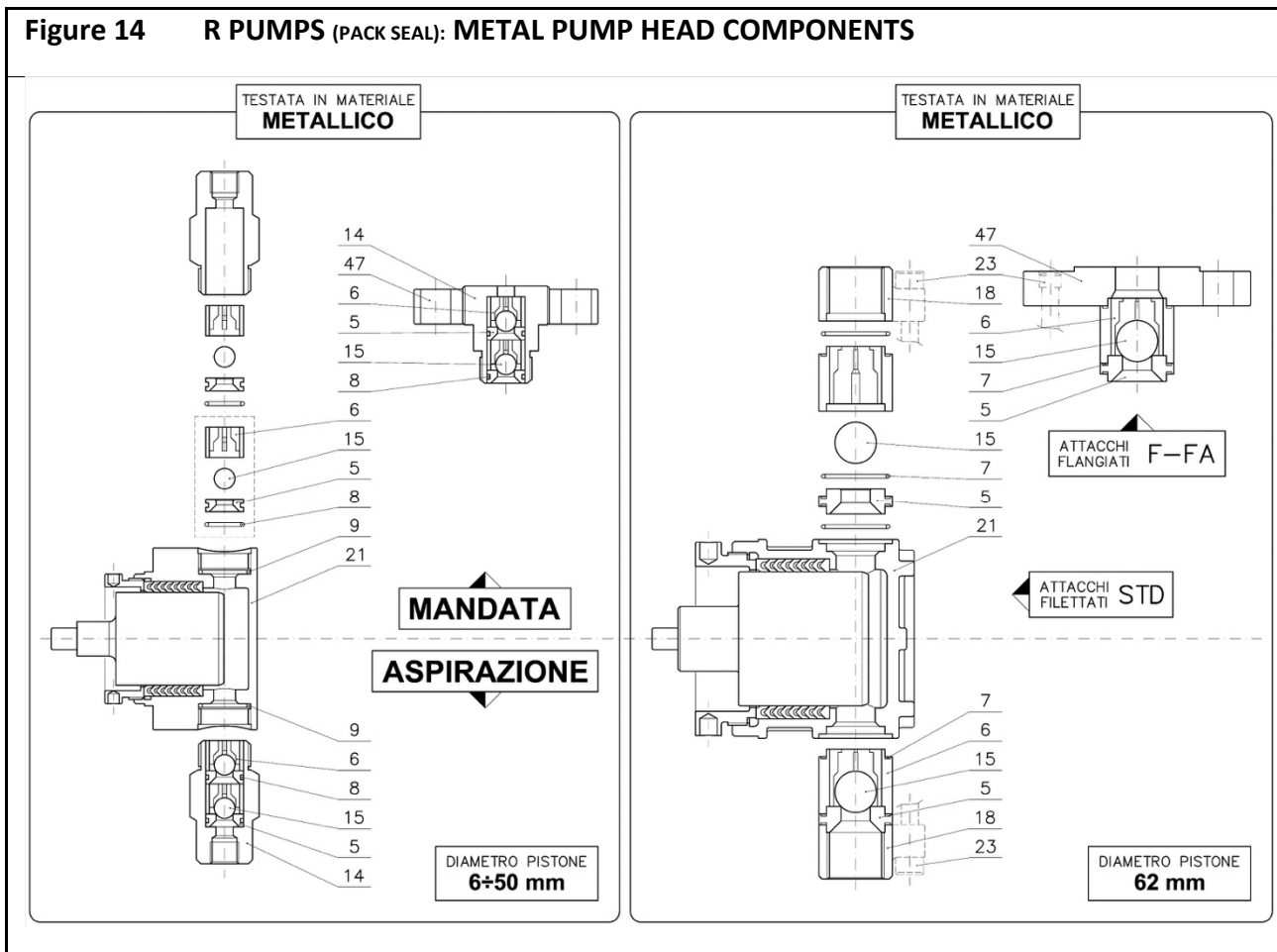

11.4.3 R type pumps with PLASTIC heads and pack seal



NOTE: BEFORE dismantling, verify there is no pressure or high temperature in the pipes!

Operate with pump OFF. Proceed as follows to check conditions and/or replace valves (see figure 15):

- free the pump from the suction and discharge pipe and perform suitable cleaning
- remove the valve containers **one at a time** (pos.14)
- carefully remove the components without damaging them (use a plastic tool)
- carefully observe and check the direction of assembly of individual components
- check the cleaning, wear and proper direction of assembly of components
- the ball (pos.15) MUST be SMOOTH and not have dents or corrosion
- the valve seat (pos.5) must have a smooth, continuous seal that is free of dents

- the seal o-rings (pos.8,9 or 55) must be whole
- replace components where necessary
- reassemble everything exactly as shown in figure 15

⚠ ATTENTION: The ball (pos.15) MUST rest on its seat (pos.5) on the surface OPPOSITE to the smooth side.

Figure 15 R PUMPS (PACK SEAL): PLASTIC PUMP HEAD COMPONENTS

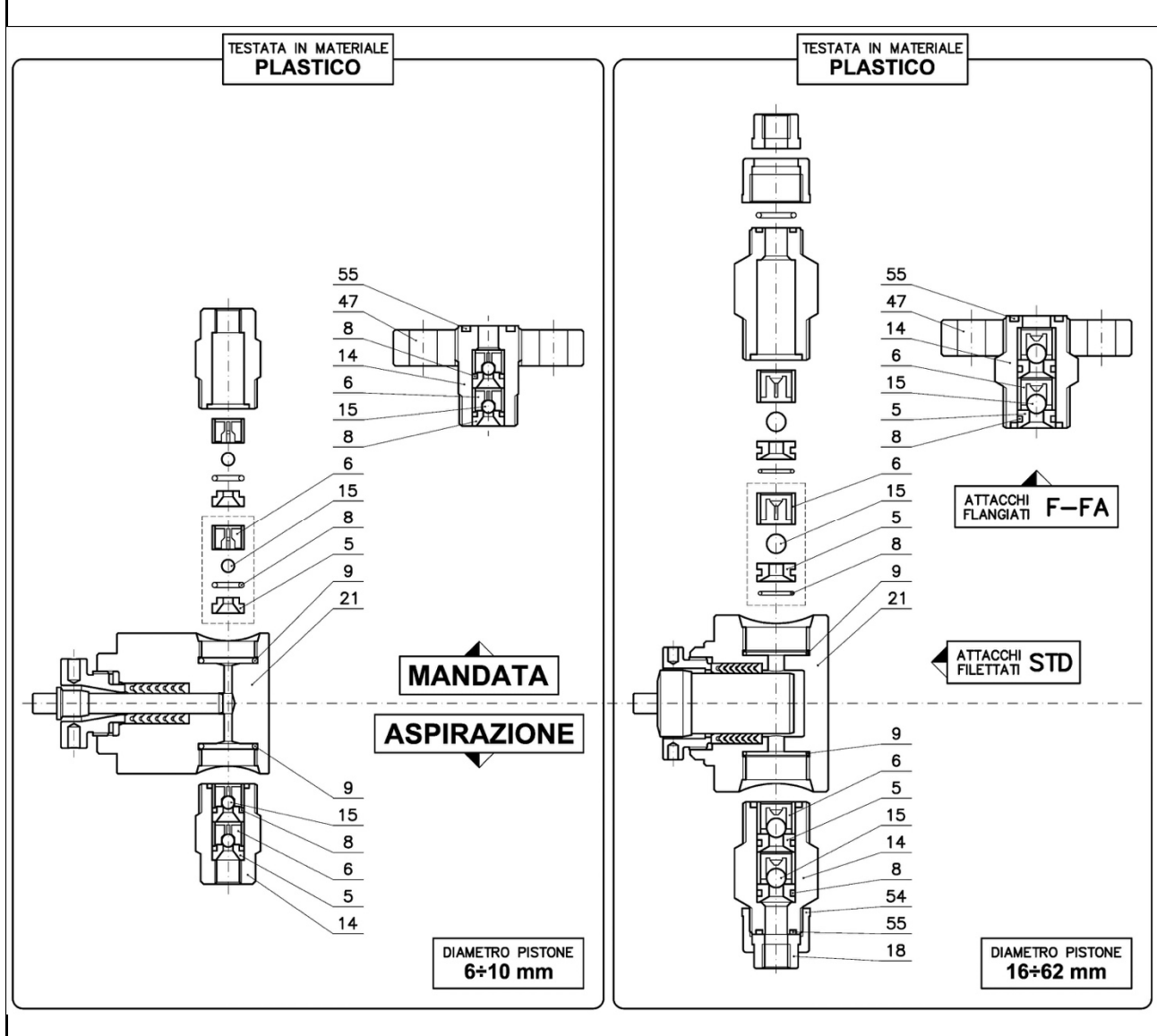

11.4.4 Pump type R-TS



NOTE: BEFORE dismantling, verify there is no pressure or high temperature in the pipes!

Operate with pump OFF. Proceed as follows to check conditions and/or replace valves (see figure 16):

- free the pump from the suction and discharge pipe and perform suitable cleaning
- remove the valve containers **one at a time** (pos.14)
- carefully remove the components without damaging them (use a plastic tool)
- carefully observe and check the direction of assembly of individual components
- check the cleaning, wear and proper direction of assembly of components
- the ball (pos.15) **MUST** be SMOOTH and not have dents or corrosion
- the valve seat (pos.5) must have a smooth, continuous seal that is free of dents
- the seal o-rings (pos.8,9 or 77) must be whole
- replace components where necessary
- reassemble everything exactly as shown in figure 16



ATTENTION: See figure 16 for proper assembly of the ball (pos.15) and the valve seat (pos.5).

Figure 16

R-TS PUMPS: PUMP HEAD COMPONENTS

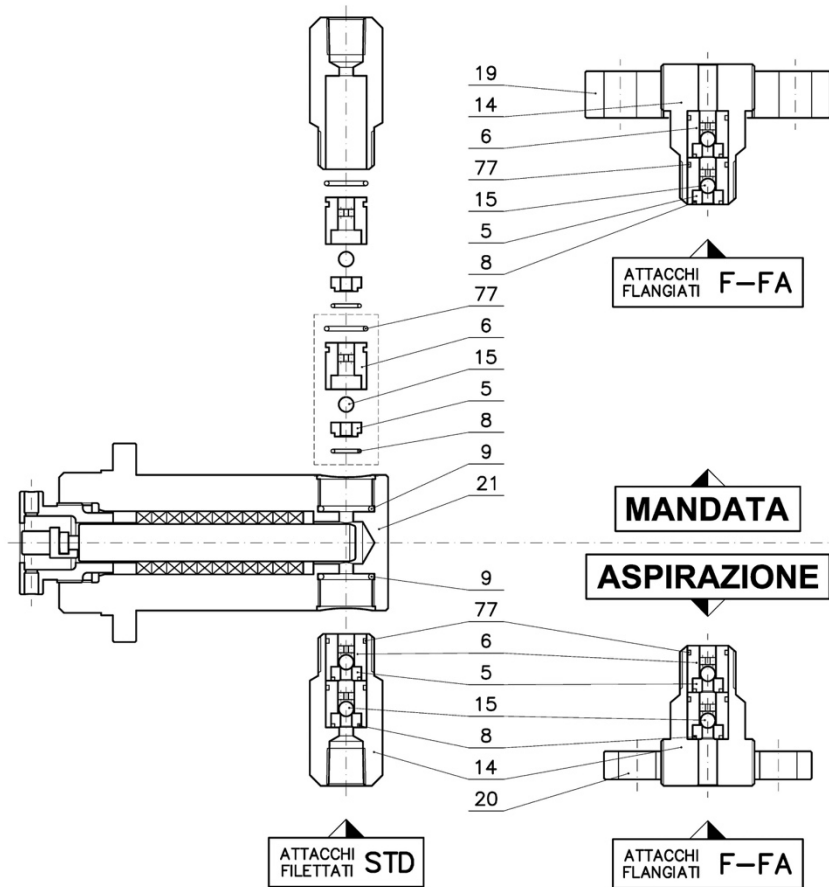

11.4.5 Pump type RH with METAL heads



NOTE: BEFORE dismantling, verify there is no pressure or high temperature in the pipes!

Operate with pump OFF. Proceed as follows to check conditions and/or replace valves (see figure 17):

- free the pump from the suction and discharge pipe and perform suitable cleaning
- plunger diameter 20-40 mm: remove the valve containers **one at a time** (pos.14)
- piston diameter 50-80 mm: dismantle **one valve unit at a time**, unscrewing the valve tensioners (pos.23)
- carefully remove the components without damaging them (use a plastic tool)
- carefully observe and check the direction of assembly of individual components
- check the cleaning, wear and proper direction of assembly of components
- the ball (pos.15) **MUST** be SMOOTH and not have dents or corrosion
- the valve seat (pos.5) must have a smooth, continuous seal that is free of dents

- the seal o-rings (pos.7,8 or 9) must be whole
- replace components where necessary
- reassemble everything exactly as shown in figure 17

⚠ ATTENTION: The ball (pos.15) MUST rest on its seat (pos.5) on the surface OPPOSITE to the smooth side.

Figure 17 RH PUMPS: METAL PUMP HEAD COMPONENTS

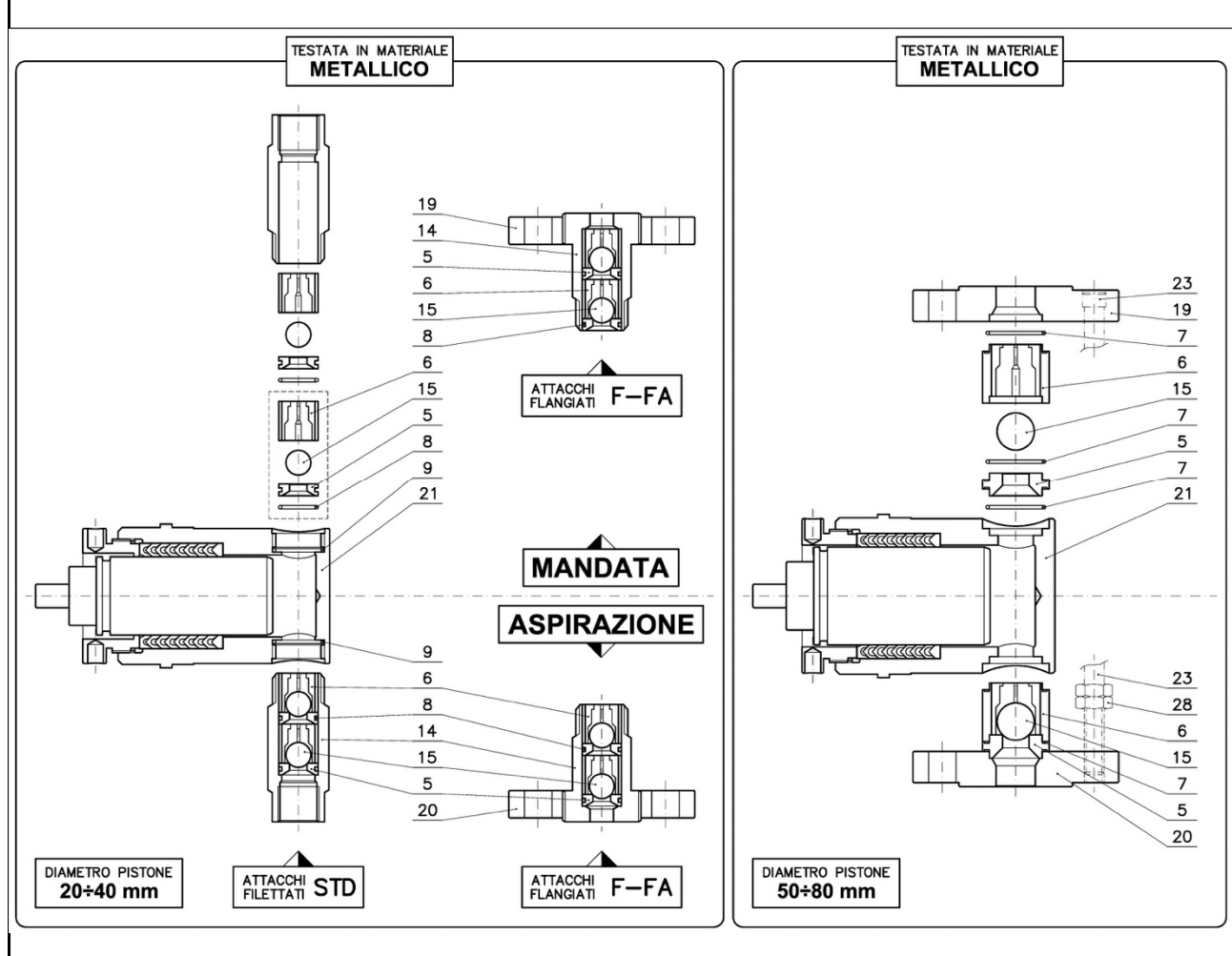

11.4.6 Pump type RH with PLASTIC heads

⚠ NOTE: BEFORE dismantling, verify there is no pressure or high temperature in the pipes!

Operate with pump OFF. Proceed as follows to check conditions and/or replace valves (see figure 18):

- free the pump from the suction and discharge pipe and perform suitable cleaning
- remove the valve containers **one at a time** (pos.14)
- carefully remove the components without damaging them (use a plastic tool)

- carefully observe and check the direction of assembly of individual components
- check the cleaning, wear and proper direction of assembly of components
- the ball (pos.15) MUST be SMOOTH and not have dents or corrosion
- the valve seat (pos.5) must have a smooth, continuous seal that is free of dents
- the seal o-rings (pos.8,9 or 55) must be whole
- replace components where necessary
- reassemble everything exactly as shown in figure 18



ATTENTION: The ball (pos.15) MUST rest on its seat (pos.5) on the surface OPPOSITE to the smooth side.

Figure 18

RH PUMPS: PLASTIC PUMP HEAD COMPONENTS

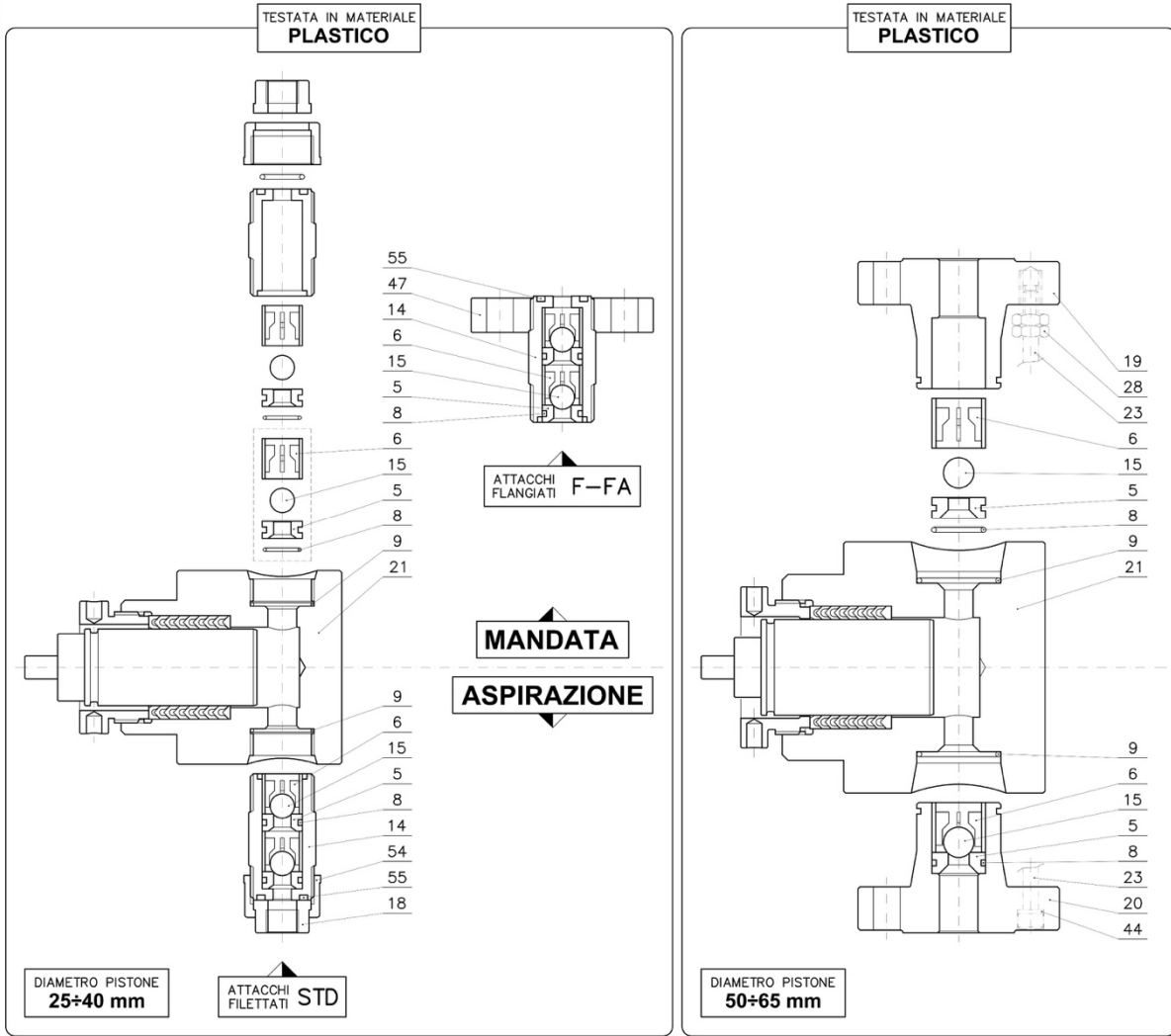

11.4.6.1 Lubricating oil changes

R series pumps are always supplied complete with lubricating oil (unless specifically requested) and ready for operation.



Each pump body in multiple pumps has its own lubrication, independent from the others.

Operate individually on each pump body to change all multiple pump lubricating oil.



Make the **FIRST** lubricating oil change after 1,000 hours of operation. Replace oil after every 15,000 operating hours in standard pump models and every 10,000 hours for ATEX pumps. Replace no later than every 5 years.



NOTE: Chemically contaminated lubricants can cause seal wear, corrosion and leakage. Preferably, always change all oil rather than simply topping up.

The oil filler cap (pos.119), the oil level cap (pos.120) and the oil drain plug (pos.121) are found on the reduction gear body.

The following images allow easy identification of the different caps.



Oil filler cap (pos.119)



Oil level cap (pos.120)



Oil drain plug (pos.121)



The following table shows the quantities and types of lubricating oil suggested:

OIL BRAND	OIL TYPE	PUMP TYPE	QUANTITY (litres)
SHELL	OMALA S2 G320	R	0.45
MOBIL	MOBILGEAR 600 XP 320	RH	1.1
IP	MELLANA 320		



The use of different lubricating oil other than that suggested is permitted only if characteristics are compatible/equivalent. Use mineral oil for gears with viscosity index ISO VG 320 (320 cSt at 40 °C or 23°E at 50 °C).

11.5 SPECIAL MAINTENANCE

The following guidelines cover the most common "special" maintenance features that only a maintenance expert can perform. Avoid impromptu operations or attempts, contact OBL customer service for specific information.

  **These maintenance suggestions are not intended as "do-it-yourself" repairs. To perform such works, specialised technical knowledge is required and operations are to be performed by qualified personnel.**

 **ATTENTION: In the case of dosing faults, check actual conditions of directional valves BEFORE dismantling the pump head (see "Valve checks and/or replacement").**

  **Appropriate personal safety devices must always be used to ensure and safeguard the personal safety of personnel, who must also be properly trained and professionally qualified.**

11.5.1 TECHNICAL DOCUMENTATION

For unforeseen "special maintenance", please contact OBL customer service (Tel. +39-02-26919.1) to receive:

- targeted and detailed information
- a copy of any specific instructions
- an updated copy of the sectional drawing

11.5.2 PUMP HEAD MAINTENANCE

The seal screw on the plunger (pos.2 or 4) or of the plunger (pos.1) mainly depend on the following factors, in order of importance:

- nature of pumped fluid (if it has suspensions, is abrasive or solidifies easily)
- actual pump operating pressure
- environmental conditions where the pump operates (environments that are dusty or saturated with acid mists)
- type of pump service (continuous or discontinuous)
- improper maintenance (lack of checks or excessive tightening of the plunger packing ring nut)

Where possible, we recommend use of diaphragm head pumps for dosing of abrasive fluid under high pressure.

11.5.3 Dismantling the pump head

Operations for dismantling the pump head to replace the plunger seal (pos.2 or 4) or to replace the plunger (pos.1) are the same for all types of pumps.

We suggest, however, reference to the following figures during operation:

- **R, R-ACV pump types (lip seal):** See figure 19
- **R pump types (pack seal):** See figure 20
- **Pump type RH:** See figure 21

Operate with pump OFF. Proceed as follows:



NOTE: BEFORE dismantling, verify there is no pressure or high temperature in the pipes!

- free the pump from the suction and discharge pipe and perform suitable cleaning
- dismantle both valve units from the head
- unscrew screws (pos.17) and remove protection covers (pos.97) from the core spindle (pos.25)
- **only for heads WITH plunger packing ring nut (pos.22):** completely unscrew the plunger packing ring nut (pos.22) and start up the pump 3 (three) or 5 (five) strokes. Plunger movement will decrease the compression of the seal on the piston (pos.2)
- bring adjustment to 0% to ensure that the plunger (pos.103) is "fully forward"
- unscrew all head locking screws (pos.29) and remove the pump head (pos.21)



NOTE: Because of the fragility of small-diameter CERAMIC plungers and/or PLASTIC heads, do NOT apply stress which can compromise component integrity during all operations

- check the cleaning, wear and proper direction of assembly of the plunger seal (pos.2 or 4)
- the plunger surface (pos.1) MUST be SMOOTH and not have scaling, scratches or corrosion
- replace components where necessary

11.5.4 Plunger seal checks and/or replacement

FIRST operate as described in "Dismantling the pump head", then proceed as follows:

- remove the plunger seal to be replaced (pos.2 or 4) without damaging the inside of the pump head (pos.21)
- clean the inside of the pump head (pos.21) and assemble the new seal on the plunger (pos.2 or 4), taking special care to follow the proper direction of assembly (see pumping heads figures)

- apply a film of grease (i.e. Vaseline) on the new plunger seal (pos.2 or 4) and inside the seal lips
- reassemble the head (pos.21) following the instructions backwards as contained in "Dismantling the pump head"
- fasten the head with clamping screws (pos.29), see "Pump head tightening torque"

11.5.5 Plunger checks and/or replacement

FIRST operate as described in "Dismantling the pump head", then proceed as follows:

- remove the locking set screw (pos.130) from the crosshead (pos.102) and then remove the plunger to be replaced (pos.1)
- apply a film of grease (i.e. Vaseline) on the new plunger shank (pos.1), then insert it in the crosshead (pos.102)
- lock in the new plunger (pos.1), inserting the locking set screw (pos.130) in the crosshead (pos.102)
- clean the plunger seal (pos.2 or 4) and apply a film of grease on it and inside the seal lips
- reassemble the head (pos.21) following the instructions backwards as contained in "Dismantling the pump head"
- fasten the head with clamping screws (pos.29), see "Pump head tightening torque"

Figure 19

R, R-ACV PUMPS (LIP SEAL): : PUMP HEAD

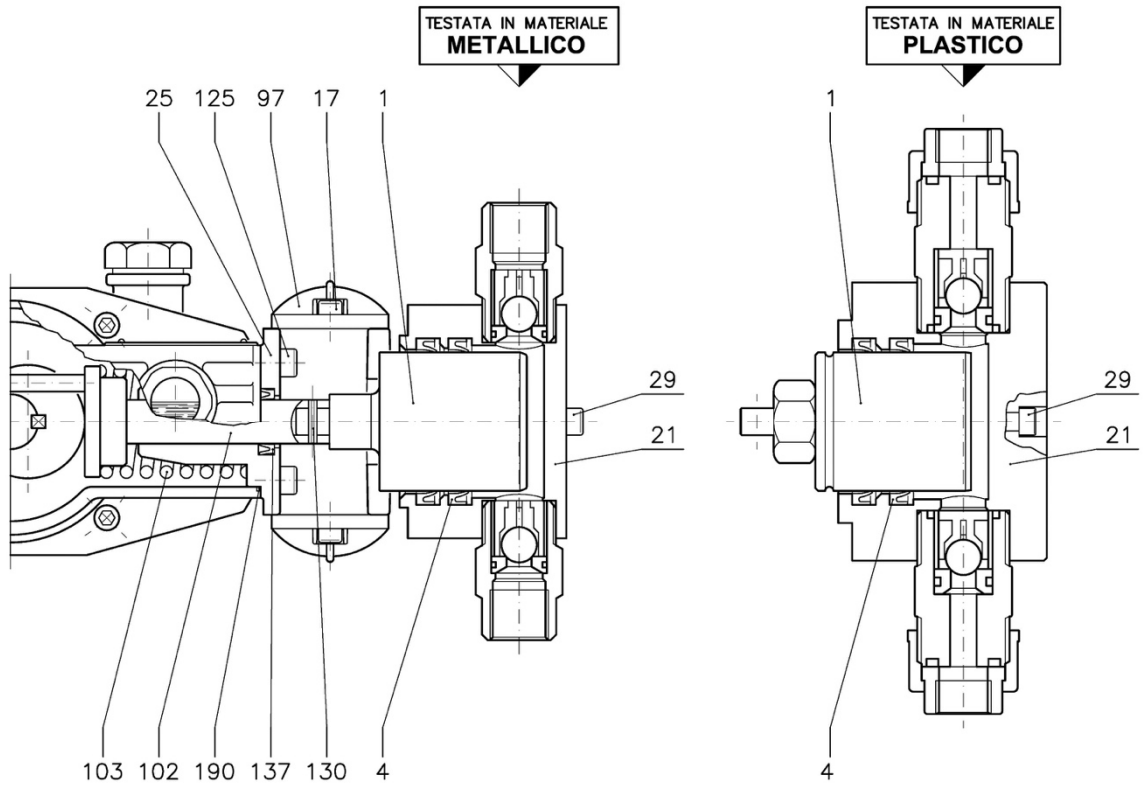

Figure 20

R PUMPS (PACK SEAL): PUMP HEAD

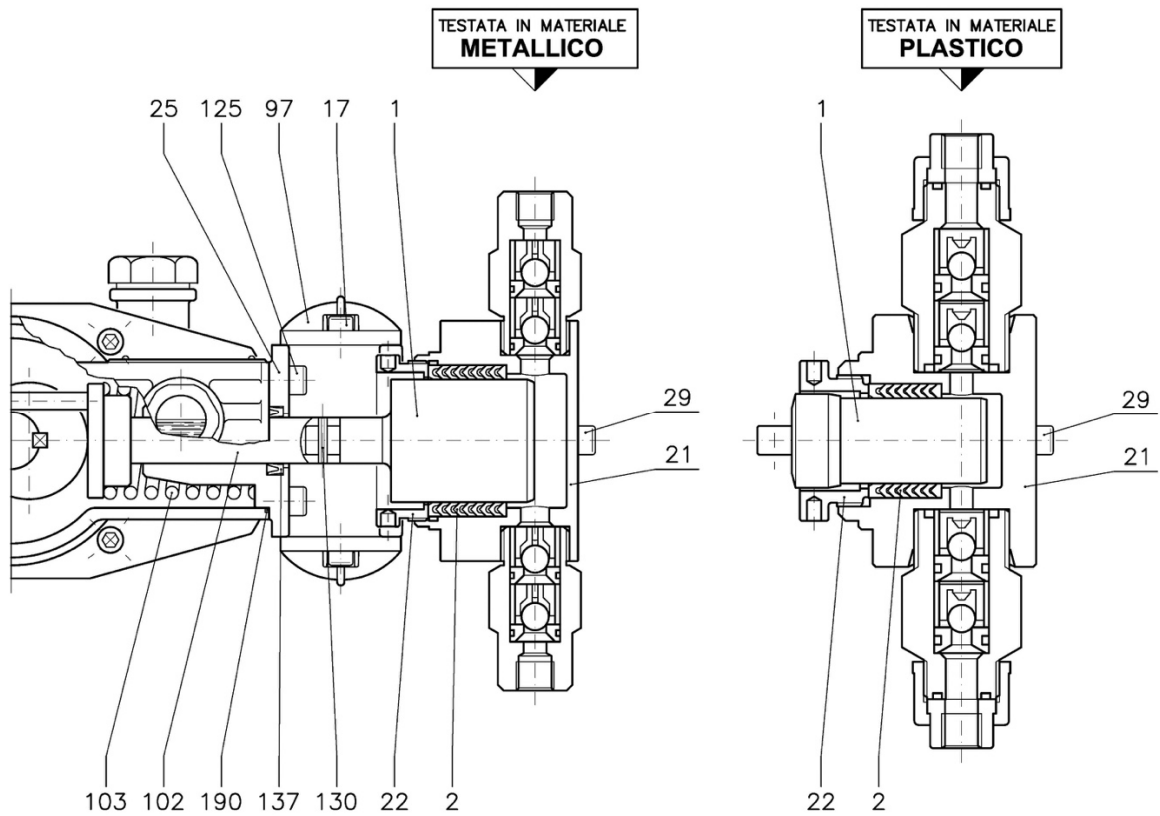
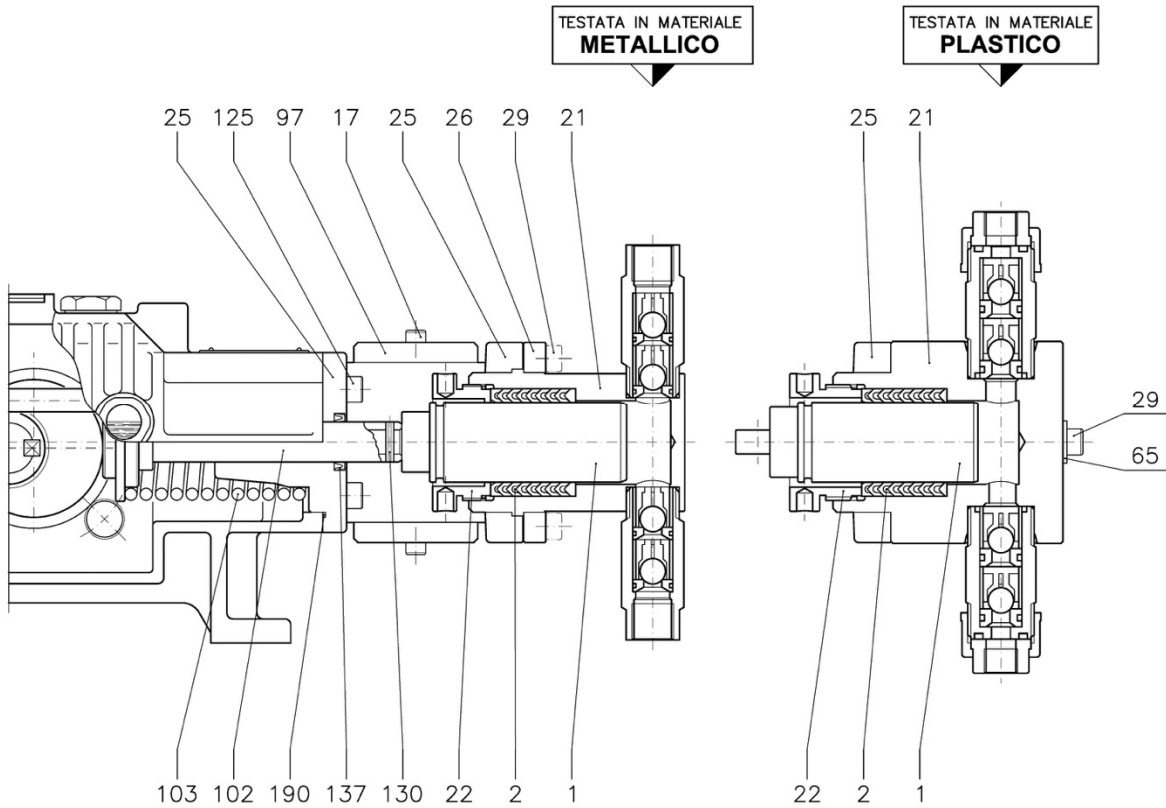

Figure 21

RH PUMPS: PUMP HEAD



11.5.6 Pump head tightening torque

The table below shows the coupling torque for locking the pump head.



NOTE: DO NOT USE BULLNOSE PLIERS - DO NOT TEFLON COAT THE THREAD THESE OPERATIONS COMPROMISE THE MECHANICAL RESISTANCE OF THE HEAD

The values are purely indicative and refer to temperatures as indicated in "Environmental and design temperature".

Proceed as follows to assemble the head: Move the head body toward the diaphragm chamber and manually tighten the screws.

Then re-tighten each screw again (at least once) until clamping is uniform.

Screws * (pos.29)	METAL head	PLASTIC head		
	METAL	PVC (P)	PVDF (S)	PP (PP)
M 6	7 Nm	3.5 Nm	3.5 Nm	3.5 Nm
M 8	16 Nm	8 Nm	8 Nm	8 Nm

NOTE * The (pos.29) is a **TCCE screw in AISI-304**



NOTE: Always use a washer (pos.65) for plastic head pumps (where applicable) to ensure appropriate load distribution, in order to avoid deformations or damage to the pump head.

11.5.6.1 Pumps with plastic heads: Recommendations



NOTE: The client (user and/or installer) must implement these recommendations.

Plastic head pumps, compared to metal head pumps, require a higher level of attention because of the mechanical characteristics of the head material and the nature and/or hazard of the chemical being pumped.

Define the most appropriate pump head tightening torque value, considering the following factors:

- if the pump is directly exposed to sunlight, to extreme changes in temperature or works near heat sources
- if the temperature of the pumped product can cause deformities or the pump head
- at what actual pressure the pump works and if there is a pulsation dampener installed on the discharge

Define an appropriate frequency of the following checks on the basis of the importance and hazard of the process:

- in the case of plunger pumps, there is no leakage from the seal on the plunger (if necessary adjust the plunger packing ring nut)
- in the case of diaphragm pumps, check the water seal on the head (if necessary adjust the tightening torque)
- checks of any head deformations due to the combined action of temperature and pressure



Any defect or irregularity detected during inspections should be promptly removed!

11.6 REPLACING BEARINGS

Replace bearings in relation to actual pump working conditions:

- **every 15,000 operating hours** for continuous operation at maximum performance
- **every 30,000 operating hours** for discontinuous operation under less severe conditions

It is advisable to use a proper sleeve exerting pressure on the coupling ring to assemble the new bearings. In the case of coupling on the shaft, support the sleeve on the internal bearing ring. For coupling on the hole, put pressure instead on the outer ring. The surfaces of the relative seats should be lightly oiled.

11.6.1 Reassembly

Before reassembly, carefully clean the internal parts and components, ensuring above all that the work surfaces of the fittings have not been damaged. Assemble oil containment fittings, taking care to preserve the conditions of the seal lips. Reassemble after a layer of grease has been restored on the strokes.



Before restarting work, see the motor fan to verify free rotation of the pump crank and confirm correct reassembly.

11.7 EMERGENCY SITUATIONS

11.7.1 Type of fire-fighting equipment to used

Use a dry carbon dioxide (CO₂)/powder fire extinguisher to put out fires on equipment.

11.7.2 Warnings on possible emissions/leakage of harmful substances

The only leakage of harmful substances are fumes and gases produced in case of fire.

12 DECOMMISSIONING

12.1 DISCONNECTING THE PLANT

BEFORE shipping, always contact OBL customer service and operate as indicated in "Provisions for goods returned to OBL".

12.1.1 PROVISIONS FOR RETURNING GOODS TO OBL (PUMPS UNDER WARRANTY)



ATTENTION: OBL reserves the right to reject any goods received without notice!

In the interest of the client/user, we kindly ask the **SENDER** to **ALWAYS** contact **OBL** customer service (Tel. +39-02-26919.1) to agree on the advantages and disadvantages of sending/repair.

These provisions are applicable for ANY reason for returning goods to OBL. Example:

- Overhaul, maintenance, conversion
- Operational/performance verification, Guarantee applicability assessment
- NEW material returns and requests of a credit notes for the wrong orders
- Other...

REQUIRED SENDER PROCEDURE

- **BEFORE** shipping, **ALWAYS** contact OBL customer service (Tel. +39-02-26919.1) to receive your **RA (Authorised Return)** number, information regarding goods returns and **related paperwork**
- **PLUNGER pumps:** Remove the entire pump head. The plunger should remain "**in sight.**" **Do not send** the "plunger seal" as it is particularly contaminated by the dosed product.
- **DIAPHRAGM pumps:** Only remove the valve units from the pump head. **Do NOT** remove the head body.
- **In general:** **ALWAYS** remove any product residue from ALL equipment. To safeguard the safety and security of the recipient, disassemble and clean each wet component and attach in a separate package.



ATTENTION: Parts considered "chemically hazardous" will be replaced and counted as a new spare part

- **Insert in packaging** (the courier often keeps them): a copy of the transport document for each piece of equipment, copy of the completely filled in declaration of conformity and the pumped/treated product Safety Data Sheet.
- Suitably package the merchandise to avoid damage from transport and indicate the **RA** number on the package.
- Ship goods **DAP Segrate** (DDP Segrate for goods coming from countries outside the EU) always with the relative transport document carrying the **RA** number to: OBL S.r.l. Via Kennedy 12 - 20090 Segrate (MILANO) ITALY



NOTE: The sender is aware of the criminal penalties for false or misleading and falsifying statements. He is also responsible for damage to persons or property arising from such actions.

12.1.2 SENDER RETURN REJECTED

If goods should arrive in OBL:

- Not adequately cleaned (and/or without a completed declaration of conformity)
- PUMPS: With pump head inadequately cleaned and/or removed
- WITHOUT RA number (Authorised Return) on the transport document and/or the package itself
- With chemicals in the package



These goods will NOT be accepted (and NO work will be done on them) and they will be returned to the sender FREIGHT UNPAID!

12.1.3 PROVISIONS FOR RETURNING GOODS TO OBL SERVICE CENTRE (PUMPS NOT UNDER WARRANTY)

In the interest of the client/user, we kindly ask the SENDER to ALWAYS contact the OBL authorised FORTI customer service (Tel. +39- 0744 800510, ricambi@fortisrl.it) to agree on the advantages and disadvantages of sending/repair.

12.2 STORAGE FOR LONG PERIODS

For long term storage (more than 6 months), observe the following precautions in addition to those described in "Storage conditions":

- Before storage: protect unpainted surfaces with long-term anti-corrosion products
- Check conditions about every 6 months. At the first sign of corrosion clean and re-apply anti-corrosion products



Report special storage conditions in advance in order to provide for adequate packaging.

12.3 DISPOSAL AND DEMOLITION

The pumps are made of metal and plastic parts.

It is the user's responsibility to comply with the procedures and regulations in the countries of operation, regarding disposing of waste resulting from maintenance (consumption material) or the demolition of equipment.

"Waste" is intended as any substance or object which the holder has decided to or is required to discard. Waste is classified according to the origin, in "urban waste" and "special waste" and, according to harmfulness, in "hazardous waste" and "non-hazardous waste".



Maintenance or demolition pump waste are classified as "special waste" only if properly cleaned. Otherwise, they are to be considered "HAZARDOUS special waste".



"Special waste" and "urban waste", and especially "hazardous" and "non-hazardous" waste, must never be mixed."

Briefly summarising:

- "special waste" must not be disposed of as "urban waste"
- this waste must be collected separately using public or private collection systems required by local laws (in an approved collection centre)
- due to its use, this equipment may contain hazardous substances. Improper disposal can have adverse effects on human health and the environment.
- administrative sanctions exist in the case of improper disposal of or abuse of waste



Disposal of substances into sewers or abandoning waste in the environment is strictly prohibited. Contact your local waste disposal service to receive adequate and accurate information regarding disposal.

13 SAFE PUMP USE

13.1 WARNINGS



METERING PUMPS ARE INDUSTRIAL MACHINERY NOT INTENDED FOR USE BY NON-PROFESSIONAL OPERATORS. THESE INSTRUCTIONS ARE INTENDED FOR QUALIFIED PERSONNEL.



ATTENTION: Plunger pumps are displacement pumps that always require a safety valve, installed externally on the discharge line (see "External safety valve") to protect against any excessive pressure. The operating pressure must NEVER exceed the maximum allowed pressure indicated on the data plate, even when opening (exhaust) the external safety valve.



FULLY AND CAREFULLY study these instructions before installing and starting the pump. Failure to respect safety recommendations can damage the machine or compromise its operation.

Comply with this information for proper management and maintenance. It is of key importance that these are read by the installer and the maintenance supervisor. This document should be stored near the machine in a safe, dry place, and in any case made easily and readily available for future reference.

Keep instructions relating directly to the equipment in good and readable condition (replace as necessary):

- Machine data plate
- Arrow indicating the motor direction of rotation
- Warning and service information adhesives

13.1.1 SYMBOLS AND SUGGESTIONS IN THESE INSTRUCTIONS



This symbol indicates important information for preventing faults and/or damage to equipment or personnel.



This symbol indicates danger due to the presence of electricity.



This symbol indicates a danger that may cause an explosion.



This symbol represents the metering pump schematically.

13.1.2 HAZARD

Metering pumps are machines with dangerous parts. Therefore:

- **improper use or tampering,**
- **removal of guards** or disconnection of protective devices,
- **inadequate inspection or maintenance** can cause serious damage to persons or property.

In particular, personnel must be informed of hazards deriving from:



- **live parts**



- **rotating or moving parts**



- **fluid pumped under pressure and/or corrosive fluid**



- **hot surfaces**

The safety supervisor must ensure and guarantee that:

- the machine is handled, installed, commissioned, inspected, maintained and repaired **by qualified personnel only**, who therefore possess:
 - specific technical training and experience
 - knowledge of technical regulations and applicable laws
 - knowledge of general, national, local and plant safety requirements
 - an ability to recognise and avoid all possible hazards

Failure to follow these guidelines, negligence or an incorrect or improper use of the machine by unauthorised and unqualified personnel may cause risk to persons or property, resulting in cancellation of the guarantee by OBL.



The safety of these machines can be compromised if they are used improperly or tampered with.

Metering pumps must be used only if they are in perfect technical condition, also considering safety aspects and danger. The smooth operation of these machines, their durability and operating efficiency depend on the observance of these details. We disclaim all responsibility for bodily injury or property damage caused by improper use of our equipment.

oblblackline.com

OBL S.r.l.

Via Kennedy, 12
20090 Segrate (MI) - Italy
Tel. +39.02.269191
Fax +39.02.2133893
obl.info@idexcorp.com
oblpumps.it

