

Fixed, flexible and container suction lines

Operating instructions

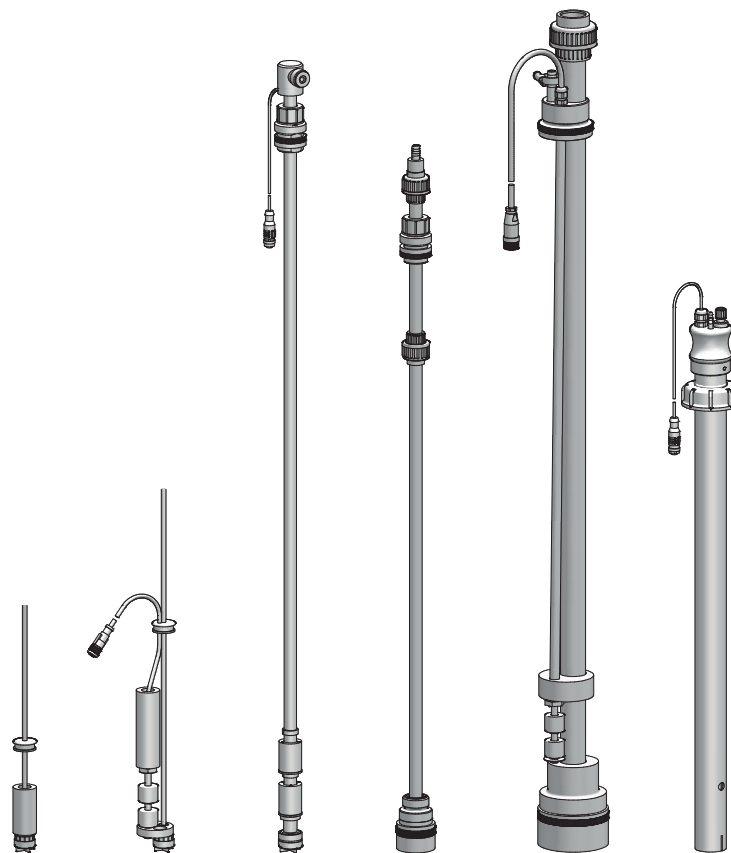

Read the operating manual!

The user is responsible for installation and operation related mistakes!

Table of Contents

1	Notes for the Reader	4
1.1	General non-discrimination	4
1.2	Explanation of the signal words	4
1.3	Explanation of the warning signs	4
1.4	Identification of warnings	4
1.5	Identification of action instructions	4
1.6	Intended use	4
2	General	5
2.1	Safety notices	5
2.2	Personal protective equipment	5
2.3	Personnel tasks	5
2.4	Hazards due to non-compliance with the safety instructions	5
2.5	Working in a safety-conscious manner	5
2.6	Personnel qualification	6
3	Product description	7
3.1	The function of the product	7
4	Dimensions	8
4.1	Flexible suction lines	8
4.2	Fixed suction lines	8
4.3	Rigid suction linea with protective tube	9
5	Technical data	10
6	Installation	12
6.1	Electrical installation	12
6.2	Hydraulic installations	12
6.3	Installing in the container	14
6.4	Height-adjustment type SC, SH and SG-2	14
6.5	Float switches	14
7	Commissioning	15
8	Transport, storage and disposal	16
9	Accessories	16
10	Maintenance	16
10.1	Maintenance intervals	16
10.2	Maintenance work	16
11	Declaration of no objection	17
12	Warranty claim	18
13	Index	19

1 Notes for the Reader

This operating manual contains information and behaviour rules for the safe and designated operation of the product.

Observe the following principles:

- Read the entire operating manual prior to commissioning the product.
- ensure that everyone who works with or on the product has read the operating manual and follows the instructions.
- maintain the operating manual throughout the service life of the product.
- pass the operating manual on to any subsequent owner of the product.

1.1 General non-discrimination

In this operating manual, only the male gender is used where grammar allows gender allocation. The purpose of this is to make the text easy to read. Men and women are always referred to equally. We would like to ask female readers for understanding of this text simplification.

1.2 Explanation of the signal words



Different signal words in combination with warning signs are used in this operating manual. Signal words illustrate the gravity of possible injuries if the risk is ignored:

Signal word	Meaning
DANGER!	Refers to imminent danger. Ignoring this sign may lead to death or the most serious injuries.
WARNING!	Refers to a potentially hazardous situation. Failure to follow this instruction may lead to death or severe injuries.
CAUTION!	Refers to a potentially hazardous situation. Failure to follow this instruction may lead to minor injury or damage to property.
PLEASE NOTE	Refers to a danger which, if ignored, may lead to risk to the machine and its function.

Tab. 1: Explanation of the signal words

1.3 Explanation of the warning signs

Warning signs represent the type and source of a danger:

Warning sign	Type of danger
	General danger
	Danger from corrosive substances
	Danger of damage to machine or functional influences

Tab. 2: Explanation of the warning signs

1.4 Identification of warnings

Warnings are intended to help you recognise risks and avoid negative consequences.

This is how warnings are identified:

Warning sign	SIGNAL WORD
Description of danger.	
Consequences if ignored.	
⇒ The arrow signals a safety precaution to be taken to eliminate the danger.	

1.5 Identification of action instructions

This is how pre-conditions for action are identified:

- ✓ Pre-condition for action which must be met before taking action.
- ✘ A resource such as a tool or auxiliary materials required to perform the operating instructions.

This is how instructions for action are identified:

- ➔ Separate step with no follow-up action.
- 1. First step in a series of steps.
- 2. Second step in a series of steps.
 - ▶ Result of the above action.

✓ **Action completed, aim achieved.**

1.6 Intended use

Fixed, flexible and container suction lines are only to be used for fluid dosing media.

Fixed, flexible and container suction lines are only to be used if installed correctly and in accordance with the technical data and other specifications of the operating manual.

Comply with the general restrictions in terms of the viscosity thresholds, chemical resistance and density. For further information, consult the Lutz-Jesco resistance list.

	WARNING
Unsuitable dosing media!	
Never use unsuitable dosing media such as flammable or radioactive media. The materials of the suction lines are not designed for such dosing media; use of the media can result in egress which can cause serious injury and damage to the machine.	
⇒ Wear appropriate personal protective equipment, especially for the protection of eyes and skin.	

2 General



2.1 Safety notices

	WARNING!
<p>Chemical burns or other burns through dosing medium!</p> <p>You may come into contact with dosing equipment when working on the product.</p> <ul style="list-style-type: none"> ⇒ Wear appropriate personal protective equipment, especially for the protection of eyes and skin. ⇒ Avoid skin contact with the dosing medium. ⇒ Check that all the screw connections have been tightened correctly and are leak-proof. ⇒ Never look into open ends of plugged hoses and valves. 	

2.2 Personal protective equipment

Based on the degree of risk posed by the dosing medium and the type of work you are carrying out, you must use corresponding protective equipment. Read the Accident Prevention Regulations and the Safety Data Sheets to the dosing media find out what protective equipment you need.

You will require the minimum of the following personal protective equipment:

Personal protective equipment required	
	Eye protection
	Protective clothing
	Protective gloves

Tab. 3: Personal protective equipment required

Wear the following personal protective equipment when performing the following tasks:

- Installation
- Operation

2.3 Personnel tasks

The table below indicates which personnel qualifications are required for the respective tasks. Only people with appropriate qualifications are allowed to perform these tasks!

Signal word	Meaning
Specialist staff	<ul style="list-style-type: none"> ■ Installing the hydraulics ■ Commissioning ■ Shut-down ■ Fault resolution ■ Maintenance ■ Disposal
Trained electricians	<ul style="list-style-type: none"> ■ Installing the electrics ■ Eliminating electrical faults
Trained persons	<ul style="list-style-type: none"> ■ Operation ■ Storage ■ Transportation

Tab. 4: Personnel qualification

2.4 Hazards due to non-compliance with the safety instructions

Failure to follow the safety instructions can endanger not only persons but also the environment and the product.

The specific consequences can be:

- Failure of major device and corresponding system functions.
- Failure of required maintenance and repair methods.
- Risk to persons when working on the product.

2.5 Working in a safety-conscious manner

Besides the safety instructions specified in this operating manual, further safety rules may apply. Always observe all safety-related regulations and guidelines applicable at the product's location of use. Note in particular the following items:

- Safety regulations on handling electricity and live components
- safety regulations on handling hazardous substances,
- Accident prevention regulations
- Safety and operating provisions
- Environmental protection provisions
- Other applicable directives and laws

2.6 Personnel qualification

Any personnel who work on the product must have appropriate special knowledge and skills.

Anybody who works on the product must meet the conditions below:

- Attendance at all the training courses offered by the owner
- Sufficient qualification for the respective activity
- Personal suitability for the respective activity
- training into the handling of the device
- knowledge of safety equipment and the way this equipment functions
- Knowledge of this operating manual, particularly of safety instructions and sections relevant for the activity.
- Knowledge of fundamental regulations regarding health and safety and accident prevention

All persons must generally have the following minimum qualification:

- Training as specialists to carry out work on the product unsupervised
- Sufficient training that they can work on the product under the supervision and guidance of a trained specialist

These operating instructions differentiate between these user groups:

2.6.1 Specialist staff

Thanks to their professional training, knowledge, experience and knowledge of the relevant specifications, specialist staff are able to perform the job allocated to them and recognise and/or eliminate any possible dangers by themselves.

2.6.2 Trained electricians

Due to their professional training, knowledge and experience as well as knowledge of specific standards and provisions, trained electricians are able to do the electrical work assigned to them and to recognise and avoid any potential dangers by themselves.

They are specially trained for their specific working environment and are familiar with relevant standards and provisions.

They must comply with the legally binding regulations on accident prevention.

2.6.3 Trained persons

Trained persons have received training from the operator about the tasks they are to perform and about the dangers stemming from improper behaviour.

Trained persons have attended all trainings offered by the operator.

3 Product description

3.1 The function of the product

Suction lines are a user-friendly, pre-prepared installation aid for connection of the suction side of a dosing pump to the dosing medium. The most important functional element is a foot valve which prevents the pumped quantity from returning and thus facilitates the trouble-free operation of the dosing pump / enables the pump to transport even small volumes. A suction filter is installed to protect the valves.

The suction lines are available as flexible and fixed versions with an adjustable length. They can also be delivered with an in-built level control for empty notification and protection against dry running. A reed switch (switched by a magnet in a float) serves as a level sensor. The deactivation point of the versions SA and SG lies c. 50 mm over the lowest suction point. This provides the operator with sufficient time to obtain further dosing media before the tank has been emptied to such an extent that the pump is switched off to prevent it from running dry.

The suction lines are available in acid and base-resistant plastics. Foot valves can also be delivered alone or with adhesive, thread or hose connections to permit special applications.

	Suction lines							
	SA	SC	SG-2	GF-2	SDL-2	SH	SL	SL-2
Flexible design	X						X	
Rigid design		X	X			X		
Rigid design with protective tube				X	X			
Base valve with non-return function and filter	X	X	X			X	X	X
Base valve with non-return function				X	X			
Connection to medium return		O	O	X				
1st level switch* (switching point)							X	
2nd level switch* (switching point)			X	X	X			X
PVC material with PP float			X					
PVC material	X	X	X	X	X	X	X	X
PP material	X		X					X
PVDF material	X		X					X
Stainless steel material	X							
PVC hose material	X	X	X	X			X	X
PE hose material	X		X					X
PTFE hose material	X		X					X
Electrical connection 3.5 mm jack plug							X	X
Electrical connection M12x1 female connector, a-coded			X	X				X
Electrical connection with wire, no plug			O	O	X			O
Use								
Canisters, drums, containers, a range of bunker tanks	X	X	X				X	X
A range of bunker tanks						X		
Canister 30 l, 60 l with K60 cap				X				
Canister 30 l, 60 l / container 100 l, drums 200 l					X			

Tab. 5: Overview versions suction lines

x = standard

o = optional

*) max contact load rating: 50 V DC/AC; 0.5 A; 10 VA (50 V DC/AC; 1 A; 20 VA for SDL-2 DN10); Use contact protector relays for inductive loads.

4 Dimensions

All dimensions in mm

4.1 Flexible suction lines

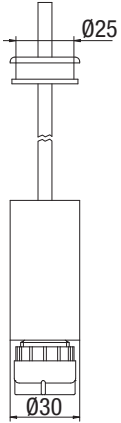

Fig. 1: Type SA

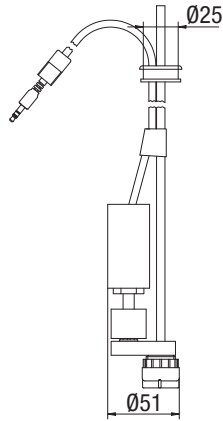

Fig. 2: Type SL

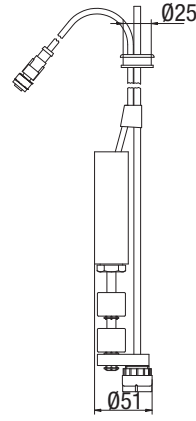

Fig. 3: Type SL-2

4.2 Fixed suction lines

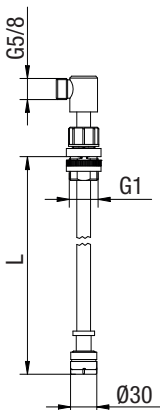

Fig. 4: Type SC

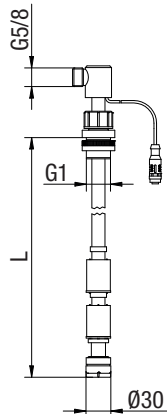

Fig. 5: Type SG-2

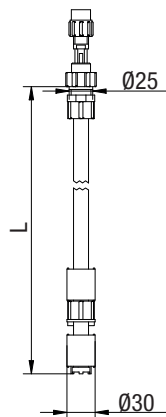

Fig. 6: Type SG-2 PP

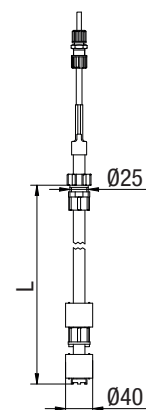

Fig. 7: Type SG-2 PVDF

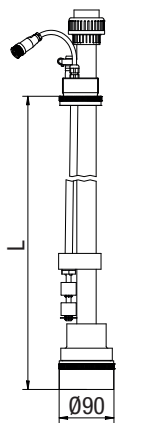

Fig. 8: Type SG-2 DN25

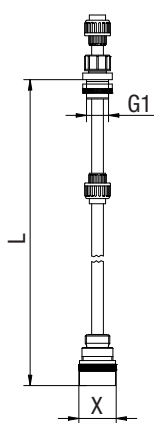

Fig. 9: Type SH

Diameter for type SH	
X	DN10 = Ø50
	DN15 = Ø70
	DN25 = Ø90

For installation lengths, please refer to Tab. 8 on page 10.

4.3 Rigid suction linea with protective tube

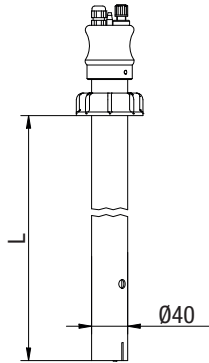

Fig. 10: Type GF-2

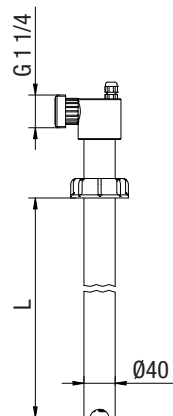

Fig. 11: Type SDL-2 DN10

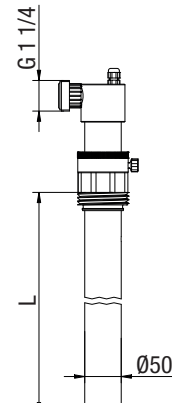

Fig. 12: Type SDL-2 DN15

For installation lengths, please refer to Tab. 9 on page 11.

5 Technical data

General						
Material		PVC / PVDF / PP				
Nominal widths and flow rates		DN4 up to 25 l/h	DN6 up to 50 l/h	DN10 up to 200 l/h	DN15 up to 400 l/h	DN25 up to 1000 l/h
Max. ambient temperature		5 – 40 °C (with PP or PVDF parts 5 – 45 °C)				
Max. temperature of the medium	PVC	35 °C				
	PVDF	60 °C				
	PP	60 °C				
Max contact load rating of level control		50 V DC/AC; 0.5 A; 10 VA (for SDL-2 DN10: 50 V DC/AC; 1 A; 20 VA)				

Tab. 6: Technical data

Flexible suction lines	Type SA				Type SL		Type SL-2	
	DN4	DN6	DN10	DN15	DN4	DN6	DN4	DN6
Nominal width								
Foot valve	with non-return function, filter and ceramic weight				with non-return function, filter and ceramic weight		with non-return function, filter and ceramic weight	
Level control (Number of switching points)	-				1		2	
Material	PVC, PP, PVDF, stainless steel			PVC	PVC	PVC, PP, PVDF		
Hose material	PVC, PE, PTFE			PVC	PVC	PVC, PE, PTFE		
Hose length in mm	2500				2500		2500	
Cable length in mm	-				2500		2500	

Tab. 7: Technical data flexible suction lines

Fixed suction lines	Type SC	Type SG-2			Type SH		
	DN6	DN4	DN6	DN25	DN10	DN15	DN25
Foot valve	with non-return function and filter	with non-return function and filter			with non-return function and filter		
Level control (Number of switching points)	-	2			-		
Material	PVC	PP, PVDF	PVC with PP float	PVC	PVC		
Type of installation	adjustable	adjustable		non-adjustable	adjustable		non-adjustable
Max installation length in mm	435, 500, 540, 710, 800, 950, 1100, 1160, 1400	500, 540, 710, 800, 950, 1100, 1160, 1400	435, 500, 540, 710, 800, 950, 1100, 1160, 1400	950	540, 750, 800, 1200, 1400, 1600		1125

Tab. 8: Technical data rigid suction lines

Rigid suction linea with protective tube	Type GF-2	Type SDL-2	
		DN10	DN15
Nominal width	DN4		
Foot valve	with non-return function	with non-return function	
Connection for media return	yes	-	
Level control (Number of switching points)	2	2	
Material	PVC	PVC	
Hose material	PVC	-	
Type of installation	adjustable	non-adjustable	
Max installation length in mm	460, 630	540, 710, 800, 950, 1100	
Hose length in mm	4500	-	

Tab. 9: Technical data rigid suction lines with protective pipe

6 Installation

This section provides an overview of the installation of the suction line. It explains the electrical installation and the hydraulic installation and provides examples to outline the container-side installation and the float switch.

6.1 Electrical installation

With a suction line with reed switches, the voltage is supplied via the level input of a dosing pump.

Suction line type	Pin assignment		
	Contact 1 = Pre-alarm	Contact 2 = Main alarm	Contact 3 = 0/ground
SL	-	red	black, white
SL-2	green	white	brown
SG-2 PVC	black	blue	brown
SG-2 PP	blue	brown	black
SG-2 PVDF until year of manufacture 07/2019	blue	brown	black
SG-2 PVDF from year of manufacture 08/2019	green	white	brown
SG-2 DN25	green	white	brown
GF-2	black	blue	brown
SDL-2	green	white	brown

Tab. 10: Cable assignments suction lines

Suction line cable assignment

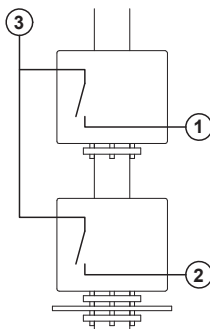

Fig. 13: Suction line cable assignment

Item	Description
1	Pre-alarm
2	Main alarm
3	0/ground

Tab. 11: Pos. numbers cable assignment of the suction line

6.2 Hydraulic installations

Connect the suction line with the suction connection of the pump. Depending on the model, the suction line has a hose clamp connection, hose liner connection, cemented connection or threaded connection.

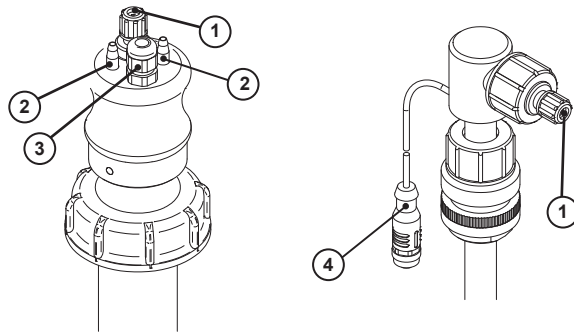

Fig. 14: Connection positions hydraulic installation

Item	Description
1	Suction connection
2	Connection spouts for return
3	Cable connection
4	Plug

Tab. 12: Pos. numbers connection positions hydraulic installation

6.2.1 Connecting the hose clamp connection

Choose the hose connection according to the condition of the hose (material, inner diameter, wall thickness) in order to ensure maximum pressure resistance.

6.2.1.1 Size 4/6 and 6/9

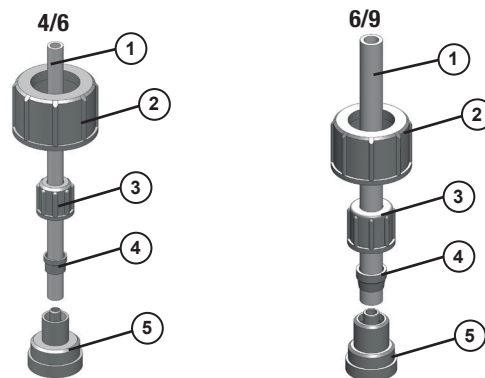

Fig. 15: Hose clips 4/6 and 6/9 (internal and external diameters in mm)

Perform the following working steps:

1. Cut the hose (1) to the appropriate length neatly and at an exact right angle.

2. Place a gasket that is suitable for the dosing medium between the connection (5) and the valve.
3. Screw the connecting piece to the suction line's connection using the union nut (2).
4. Thread the union nut (3) and the clamping ring (4) onto the hose.
5. Plug the hose all the way in to the grommet of connection piece.
6. Push the clamping ring onto the grommet of connection piece and screw it to the union nut.

✓ **Hose clamp connection connected.**

6.2.1.2 Size 6/12

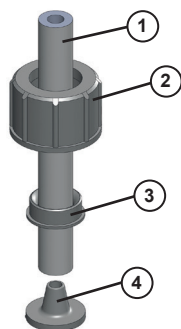

Fig. 16: Hose clip 6/12 (internal and external diameters in mm)

Hose clamp connections size 6/12 only have one union nut. It clamps the hose onto the grommet of the connection piece and at the same time fastens.

Perform the following working steps:

1. Cut the hose (1) to the appropriate length neatly and at an exact right angle.
2. Place a gasket that is suitable for the dosing medium between the connection (4) and the valve.
3. Push the union nut (2) and the cutting ring (3) over the hose.
4. Press the end of the hose onto the grommet of connection piece. You can do this more easily by moistening the end of the hose on the inside or applying some lubricant to the grommet in the cone area. You should push at least two thirds of the hose onto the grommet of the connection piece.
5. Push the cutting ring over the hose into the cone area on the grommet of connection piece.
6. Screw the union nut onto the connection of the suction line.

✓ **Hose clamp connection connected.**

6.2.2 Connecting the cemented connection

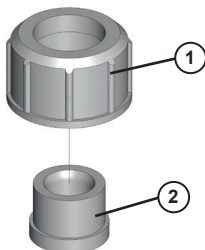

Fig. 17: Stick-on connector

Perform the following working steps:

1. Cut the PVC tube to needed length.
2. Push the union nut (1) onto the tube.
3. Glue the cemented sleeve (2) to the pipe (follow the manufacturer's instructions for the adhesive).
4. Screw the union nut onto the connection of the suction line. Use a gasket that is suitable for the dosing medium.

✓ **Cemented connection connected.**

6.2.3 Connecting the threaded connection

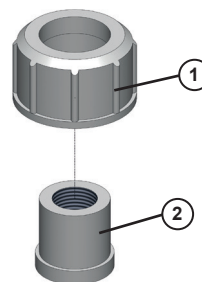

Fig. 18: Threaded connection

Perform the following working steps:

1. Cut the tube to needed length.
2. Cut the thread (2) onto the end of the tube.
3. Push the union nut (1) onto the tube.
4. Seal the thread. When choosing your sealing material, take into account its resistance to material, temperature and pressure.
5. Screw the union nut onto the connection of the suction line. Use a gasket that is suitable for the dosing medium.

✓ **Threaded connection connected.**

6.3 Installing in the container

Every suction line (except type SDL-2 DN15) is delivered with an attachment (screw cap, clamping bushing or rubber bushing) to facilitate installation to a container. The attachment (screw cap) must be screwed on to the container and not the cap. Flexible suction lines can be shortened to the required size, fixed suction lines can be set to the required length using a screw cap or clamping bushing.

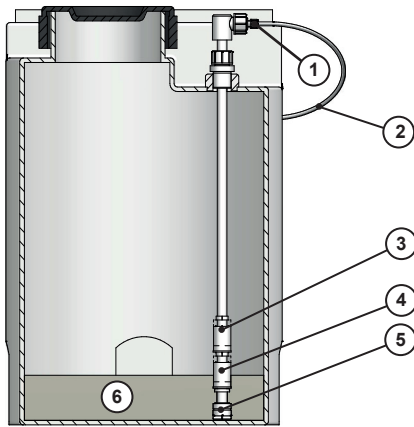

Fig. 19: SG-2 suction line in 75 litre container

Item	Description
1	Hose connection
2	Hose
3	Pre-alarm
4	Main alarm
5	Foot valve
6	Medium dosed

Tab. 13: Position numbers suction line SG-2 in 75 litre container

Item	Description
1	Threaded ring
2	Threaded sleeve
3	Clamping bushing
4	Union nut

Tab. 14: Pos. numbers height adjustment suction lines

Perform the following working steps:

Container with threaded sleeve:

1. Remove the threaded ring (1).
2. Screw the suction line into the threaded sleeve (2) of the container.

Container with a simple drill-hole:

1. Insert the suction line through the aperture in the container.
2. Screw the threaded ring (1) onto the clamping bushing (3) from the inside.

Adapt the suction line to the height of the container:

1. Loosen the union nut (4).
 - You can now move the suction line.
2. Retighten the union nut once the desired position has been reached.

✓ **Height adjustment for the suction line performed.**

6.5 Float switches

When the float moves upwards, the reed switch closes. This means that the contact is closed when the container is full and the float is floating high; it is open when the container is empty and the float is floating low.

6.4 Height-adjustment type SC, SH and SG-2

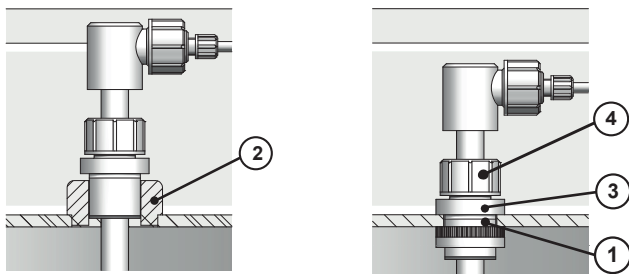



Fig. 20: Height adjustment suction lines

7 Commissioning

	WARNING!
<p>Chemical burns or other burns through dosing medium!</p> <p>You may come into contact with dosing equipment when working on the product.</p> <ul style="list-style-type: none"> ⇒ Wear appropriate personal protective equipment, especially for the protection of eyes and skin. ⇒ Avoid skin contact with the dosing medium. ⇒ Check that all the screw connections have been tightened correctly and are leak-proof. ⇒ Never look into open ends of plugged hoses and valves. 	

	WARNING!
<p>Hazardous material!</p> <p>Never use unsuitable dosing media such as flammable or radioactive media. The materials of the suction lines are not designed for such dosing media; use of the media can result in egress which can cause serious injury and damage to the machine.</p> <ul style="list-style-type: none"> ⇒ Wear appropriate personal protective equipment, especially for the protection of eyes and skin. 	

The following conditions must be established to permit commissioning:

- ✓ The suction line has been installed electrically.
- ✓ The suction line has been installed hydraulically.

	<p>Under normal conditions, you only need to screw the hydraulic connections finger-tight. However, due to the material settling, the pre-tension of the screw connection can slacken. This means that you must re-tighten the screw connection before carrying out commissioning.</p>
---	--

Perform the following working steps:

1. Check for the correct installation of the seals.
 2. Tighten all the screw connections hand-tight.
 3. Make sure that the hose connections are fastened securely and check them for leak-tightness.
 4. Secure the hose with hose clips or a union nut.
- ✓ **The suction line has been commissioned.**

8 Transport, storage and disposal

The suction lines are delivered in cardboard packaging and should always be transported in it:

- The packaging material is re-usable.
- The suction lines are to be completely emptied and cleaned before storage.
- The ambient conditions are to be observed.

9 Accessories

The following accessories are available for the suction lines:

- Hose clamp connection
- Stick-on connector
- Threaded connection
- Clamping bushing
- Reduction
- Adapter for extending the standard connecting cable
- Adapter (for pump types LD / LK / LP if using older suction lines with a 3.5 mm jack plug)

10 Maintenance

Products by Lutz-Jesco are manufactured to the highest quality standards and have a long service life. However, some parts are subject to operational wear. This means that regular visual inspections are necessary to ensure a long operating life. Regular maintenance will protect the device from operation interruptions.

10.1 Maintenance intervals

This table gives you an overview of maintenance work and the intervals at which you must carry it out.

Interval	Maintenance
Monthly	■ Visual check

Tab. 15: Maintenance intervals

10.2 Maintenance work

Check all seals as required and replace if necessary. We recommend cleaning the screen and floats as required.

11 Declaration of no objection

Declaration of no objection

Please fill out a separate form for each appliance!

We forward the following device for repairs:

Device and device type: Part-no.:

Order No.: Date of delivery:

Reason for repair:

.....

.....

Dosing medium

Description: Irritating: Yes No

Properties: Corrosive: Yes No

We hereby certify, that the product has been cleaned thoroughly inside and outside before returning, that it is free from hazardous material (i.e. chemical, biological, toxic, flammable, and radioactive material) and that the lubricant has been drained.

If the manufacturer finds it necessary to carry out further cleaning work, we accept the charge will be made to us.

We assure that the aforementioned information is correct and complete and that the unit is dispatched according to the legal requirements.

Company / address: Phone:

..... Fax:

..... Email:

Customer No.: Contact person:

Date, Signature:

12 Warranty claim

Warranty claim

Please copy and send it back with the unit!

If the device breaks down within the period of warranty, please return it in a cleaned condition with the complete warranty claim.

Sender

Company: Phone: Date:

Address:

Contact person:

Manufacturer order no.: Date of delivery:

Device type: Serial number:

Nominal capacity / nominal pressure:

Description of fault:

.....
.....
.....
.....
.....
.....
.....
.....
.....
.....

Service conditions of the device

Point of use / system designation:

.....

Accessories used (suction line etc.):

.....

.....

.....

.....

Commissioning (date):

Duty period (approx. operating hours):

.....

Please describe the specific installation and enclose a simple drawing or picture of the chemical feed system, showing materials of construction, diameters, lengths and heights of suction and discharge lines.

13 Index

C

Cemented connection 13

D

Dimensioned drawings 8

Dimensions 8

H

Handling instructions

 Marking 4

M

Maintenance intervals 16

N

Notes for the Reader 4

P

Personnel qualification 6

S

Signal words

 Explanation 4

Specialist staff 6

T

Threaded connection 13

Trained electricians 6

Trained persons 6

W

Warnings

 Marking 4

Warning sign

 Explanation 4

Working in a safety-conscious manner 5

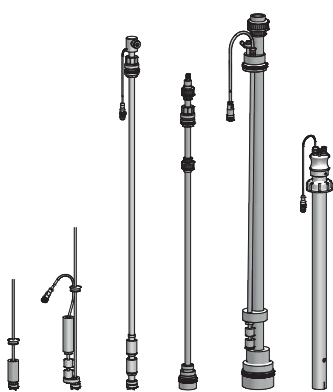

Lutz-Jesco GmbH

Am Bostelberge 19
D-30900 Wedemark

Phone: +49 5130 5802-0
info@lutz-jesco.com
www.lutz-jesco.com

Operating instructions
Fixed, flexible and container suction lines